



Cardiovascular Surgery
Herz-u. Gefäßchirurgie
Cirurgía cardiovascular
Chirurgie cardio-vasculaire
Chirurgia cardiovascolare



11-110-23
23 cm, 9"



JOHNS HOPKINS
11-100-03
11-103-09

11-100-03
3,5 cm, 1½"

11-100-04
5 cm, 2"

11-100-06
6 cm, 2½"

11-100-07
6,5 cm, 2½"

11-102-07
7 cm, 2¾"

11-102-08
7,5 cm, 3"

11-102-09
9 cm, 3½"

11-101-03
3,5 cm, 1½"

11-101-04
5 cm, 2"

11-101-06
6 cm, 2½"

11-101-07
6,5 cm, 2½"

11-103-07
7 cm, 2¾"

11-103-08
7,5 cm, 3"

11-103-09
9 cm, 3½"



DIEFFENBACH
11-110-03
11-111-05

11-110-03
3,5 cm, 1½"

11-110-05
5 cm, 2"

11-111-03
3,5 cm, 1½"

11-111-05
5 cm, 2"



DIEFFENBACH
11-118-06
11-119-06

11-118-06
6 cm, 2½"

11-119-06
6 cm, 2½"

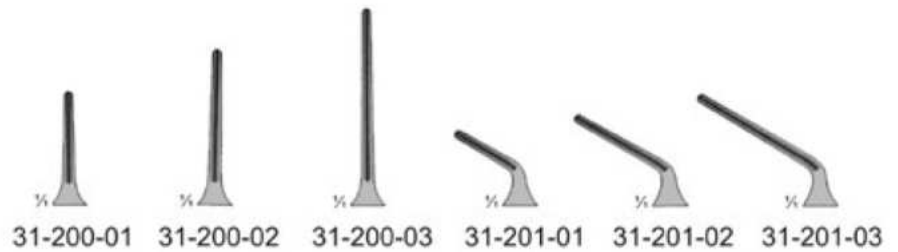

DIETHRICH
31-200-01
31-201-03



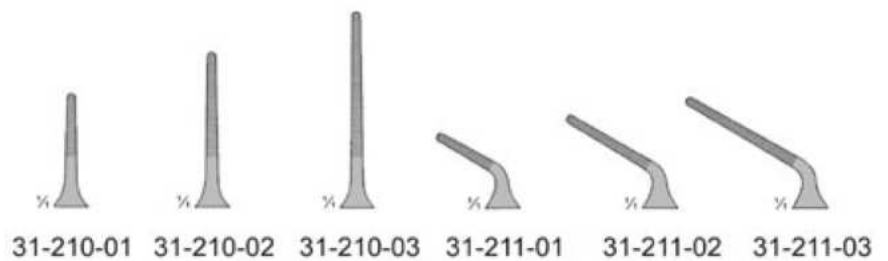









Length Länge Longitud Longueur Lungth	50 mm	50 mm	60 mm	50 mm	50 mm	60 mm
Length of jaw Maullänge Longitud de boca Longueur des mors Lungh dei morsi	10 mm	14 mm	20 mm	14 mm	14 mm	20 mm
Occlusion pressure Schließdruck Presión de oclusión Pression d'occlusion Pessione occlusiva	3 gr	3 gr	3 gr	3 gr	3 gr	3 gr
Weight Gewicht Peso Poids Peso	180 gr	180 gr	180 gr	180 gr	180 gr	180 gr

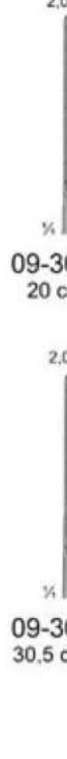











DIETHRICH
31-210-01
31-211-03

Length Länge Longitud Longueur Lungth	50 mm	50 mm	60 mm	50 mm	50 mm	60 mm
Length of jaw Maullänge Longitud de boca Longueur des mors Lungh dei morsi	8 mm	12 mm	20 mm	8 mm	12 mm	20 mm
Occlusion pressure Schließdruck Presión de oclusión Pression d'occlusion Pessione occlusiva	3 gr	3 gr	3 gr	3 gr	3 gr	3 gr
Weight Gewicht Peso Poids Peso	50 gr	50 gr	50 gr	50 gr	50 gr	50 gr



 <p>1,5 mm 09-300-15 15,5 cm, 6"</p>  <p>1,5 mm 09-300-20 20 cm, 8"</p>  <p>1,5 mm 09-300-24 24 cm, 9½"</p> <p>De Bakey</p> <p>09-300-15 09-300-24</p>	 <p>2,0 mm 09-306-15 15,5 cm, 6"</p>  <p>2,0 mm 09-306-20 20 cm, 8"</p>  <p>2,0 mm 09-306-24 24 cm, 9½"</p>  <p>2,0 mm 09-306-30 30,5 cm, 12"</p> <p>De Bakey</p> <p>09-306-15 09-306-30</p>	 <p>2,7 mm 09-312-15 15,5 cm, 6"</p>  <p>2,7 mm 09-312-20 20 cm, 8"</p>  <p>2,7 mm 09-312-24 24 cm, 9½"</p>  <p>2,7 mm 09-312-30 30,5 cm, 12"</p> <p>De Bakey</p> <p>09-312-15 09-312-30</p>	 <p>2,0 mm 09-316-16 16 cm, 6¼"</p>  <p>2,0 mm 09-316-20 20 cm, 8"</p> <p>Cooley</p> <p>09-316-16 09-316-20</p>
--	---	---	--

 <p>3,5 mm 09-322-15 15,5 cm, 6"</p>  <p>3,5 mm 09-322-20 20 cm, 8"</p>  <p>3,5 mm 09-322-24 24 cm, 9½"</p>  <p>3,5 mm 09-322-30 30,5 cm, 12"</p> <p>De Bakey</p> <p>09-322-15 09-322-30</p>	 <p>2,0 mm 09-326-15 15 cm, 6"</p>  <p>2,0 mm 09-326-19 19,5 cm, 7¾"</p>  <p>2,7 mm 09-326-23 23,5 cm, 9¼"</p>  <p>2,0 mm 09-326-30 30 cm, 12"</p> <p>De Bakey</p> <p>09-326-15 09-326-30</p>	 <p>1,5 mm 09-330-12 12 cm, 4¾"</p>  <p>1,5 mm 09-330-15 15 cm, 6"</p> <p>ADSON</p> <p>09-330-12 09-330-15</p>
--	--	---



 1,5 mm 09-302-15 15,5 cm, 6" 1/4 1,5 mm 09-302-20 20 cm, 8" 1/4 1,5 mm 09-302-24 24 cm, 9 1/2" 1/4 De Bakery Titanium	 2,0 mm 09-308-15 15,5 cm, 6" 1/4 2,0 mm 09-308-20 20 cm, 8" 1/4 2,0 mm 09-308-24 24 cm, 9 1/2" 1/4 2,0 mm 09-308-30 30,5 cm, 12" 1/4 De Bakery Titanium	 2,7 mm 09-314-15 15,5 cm, 6" 1/4 2,7 mm 09-314-20 20 cm, 8" 1/4 2,7 mm 09-314-24 24 cm, 9 1/2" 1/4 2,7 mm 09-314-30 30,5 cm, 12" 1/4 De Bakery Titanium	 2,0 mm 09-318-16 16 cm, 6 1/4" 1/4 2,0 mm 09-318-20 20 cm, 8" 1/4 Cooley Titanium
---	---	---	---

 3,5 mm 09-324-15 15,5 cm, 6" 1/4 3,5 mm 09-324-20 20 cm, 8" 1/4 3,5 mm 09-324-24 24 cm, 9 1/2" 1/4 3,5 mm 09-324-30 30,5 cm, 12" 1/4 De Bakery Titanium	 2,0 mm 09-328-15 15 cm, 6" 1/4 2,0 mm 09-328-19 19,5 cm, 7 1/4" 1/4 2,7 mm 09-328-23 23,5 cm, 9 1/4" 1/4 2,0 mm 09-328-30 30 cm, 12" 1/4 De Bakery Titanium	 1,5 mm 09-332-12 12 cm, 4 3/4" 1/4 1,5 mm 09-332-15 15 cm, 6" 1/4 ADSON Titanium
---	---	--



31-340-07
7,5 cm, 3"

31-340-07
31-340-12



31-340-08
8,5 cm, 3 1/4"
31-340-10
10,5 cm, 4 1/4"
31-340-12
12 cm, 4 3/4"



31-341-07
7 cm, 2 3/4"

31-341-07
31-341-12



31-341-08
8 cm, 3 1/4"
31-341-10
10 cm, 4"
31-341-12
12 cm, 4 3/4"



SANTULLI
31-351-07
7 cm, 2 3/4"

Carotid clamps
 Karotisklemmen
 Pinzas-clamps
 para carótis
 Pincés-clamps
 pour la carotide
 Pinze per la
 carotide



GREGORY-SOFT
31-353-09
31-353-11

Carotid clamps
 Karotisklemmen
 Pinzas-clamps para carótis
 Pincés-clamps pour la carotide
 Pinze per la carotide



31-353-09
9 cm, 3 1/2"
31-353-11
11 cm, 4 1/2"



31-355-01
11 cm, 4 1/2"
31-355-02
11 cm, 4 1/2"

Carotid clamps
 Karotisklemmen
 Pinzas-clamps para carótis
 Pincés-clamps pour la carotide
 Pinze per la carotide

GREGORY-SOFT
31-355-01
31-355-02



Occlusion pressure adjustable
 Schließdruck einstellbar
 Presion de oclución ajustable
 Pression d'occlusion ajustable
 Pressione occlusiva regolabile

31-360-06 6 cm, 2½"
 31-360-07 7 cm, 2¾"
 31-360-09 9 cm, 3½"
 31-360-11 11 cm, 4½"

GLOVER
 31-360-06
 31-360-11

31-361-05 5,5 cm, 2½"
 31-361-06 6,5 cm, 2¾"
 31-361-08 8,5 cm, 3½"
 31-361-10 10,5 cm, 4½"

GLOVER
 31-361-05
 31-361-10



GLOVER
 31-363-05
 5 cm, 2"



DE BAKEY-SATINSKY
 31-365-07
 7 cm, 2¾"



DE BAKEY-CAROTIS
 31-367-09
 9 cm, 3½"

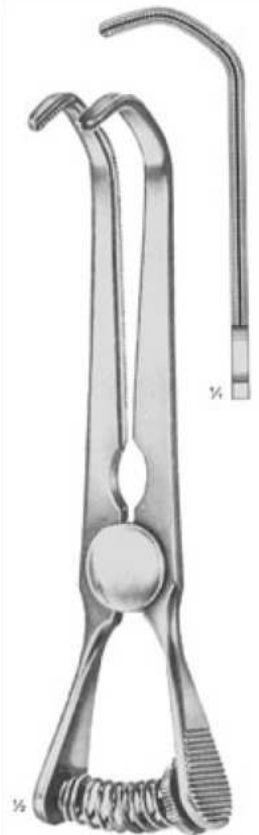

DE BAKEY-SATINSKY
 31-369-10
 10 cm, 4"



11-152-12
12 cm, 4 3/4"
11-152-15
15 cm, 6"
11-153-12
12 cm, 4 3/4"
11-153-15
15 cm, 6"

**DE BAKEY
HALSTED-MOSQUITO**
11-152-12
11-153-15



11-200-16
16 cm, 6 1/4"
11-201-16
16 cm, 6 1/4"

**DE BAKEY
CRILE-RANKIN**
11-200-16
11-201-16



DE BAKEY
31-370-12
12cm, 4 3/4"



DE BAKEY
31-371-12
12 cm, 4 3/4"



31-375-13
13 cm, 5 1/4"
31-377-13
13 cm, 5 1/4"

DE BAKEY
31-375-13
31-377-13



DE BAKEY
31-381-10
10 cm, 4"

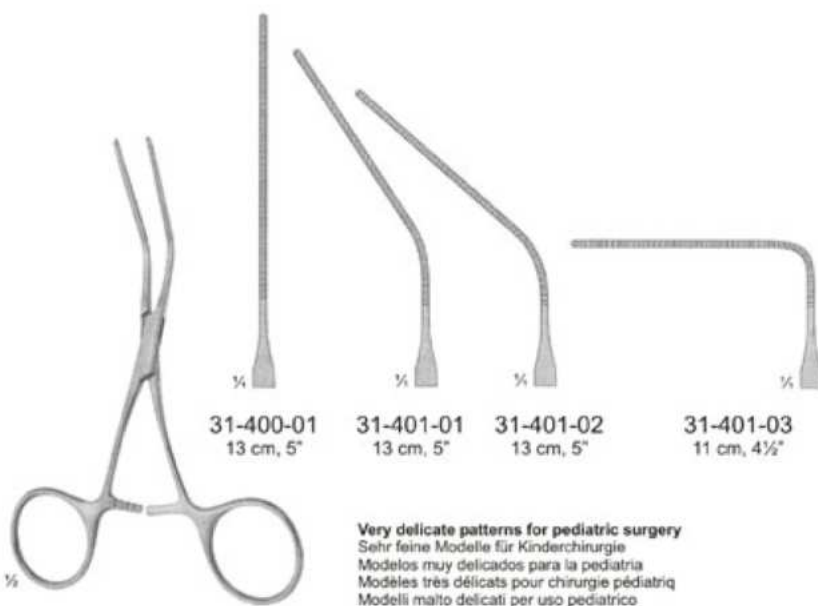

31-400-01
13 cm, 5"

31-401-01
13 cm, 5"

31-401-02
13 cm, 5"

31-401-03
11 cm, 4 1/2"

Very delicate patterns for pediatric surgery
Sehr feine Modelle für Kinderchirurgie
Modelos muy delicados para la pediatría
Modèles très délicats pour chirurgie pédiatrique
Modelli molto delicati per uso pediatrico

CASTANEDA
31-400-01
31-401-03

Multi-purpose clamps
Mehrzweckklemmen
Pinzas-clamps de varias aplicaciones
Pincers-clamps universelles
Pinze multiuso

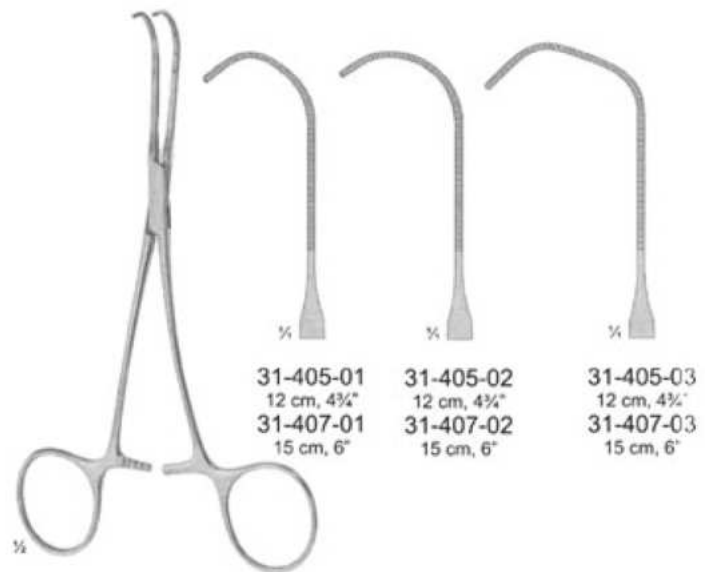

31-405-01
12 cm, 4 3/4"

31-405-02
12 cm, 4 3/4"

31-405-03
12 cm, 4 3/4"

31-407-01
15 cm, 6"

31-407-02
15 cm, 6"

31-407-03
15 cm, 6"

CASTANEDA
31-405-01
31-407-03

Very delicate patterns for pediatric surgery
Sehr feine Modelle für Kinderchirurgie
Modelos muy delicados para la pediatría
Modèles très délicats pour chirurgie pédiatrique
Modelli molto delicati per uso pediatrico

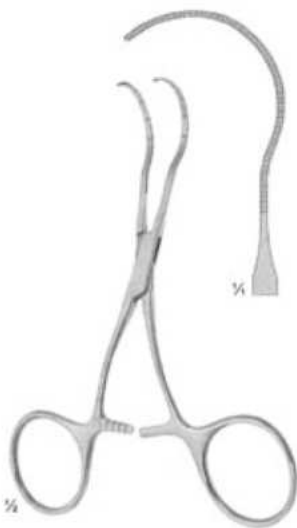

CASTANEDA
31-409-12
12 cm, 4 1/2"

Multi-purpose clamps
Mehrzweckklemmen
Pinzas-clamps de varias aplicaciones
Pincers-clamps universelles
Pinze multiuso



31-415-01
15 cm, 6"

31-415-02
15 cm, 6"

31-415-03
15 cm, 6"

31-415-04
15 cm, 6"

31-413-01
12 cm, 4 3/4"

31-413-02
12 cm, 4 3/4"

31-413-03
12 cm, 4 3/4"

31-413-03
12 cm, 4 3/4"

CASTANEDA
31-413-01
31-415-04

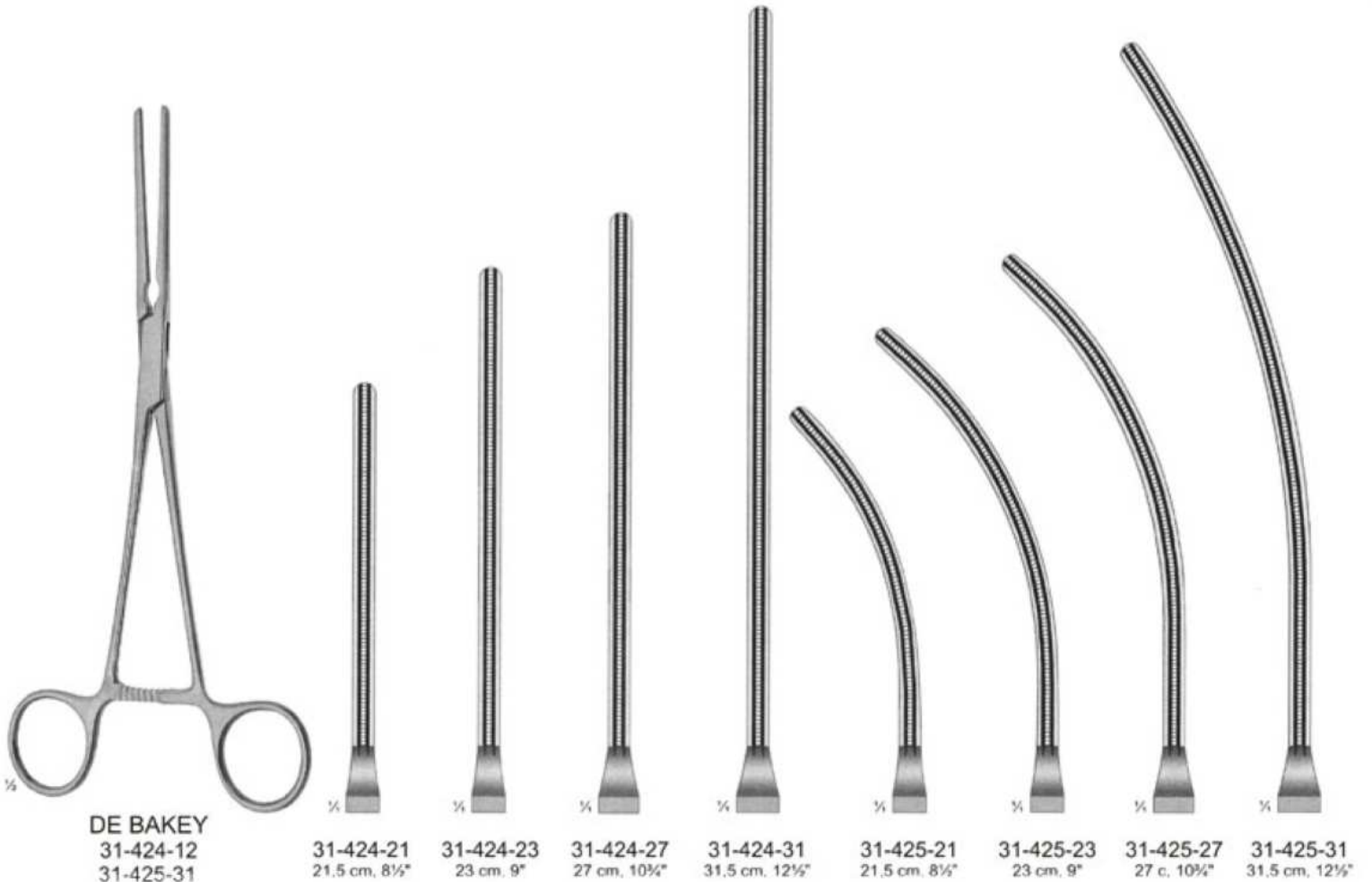
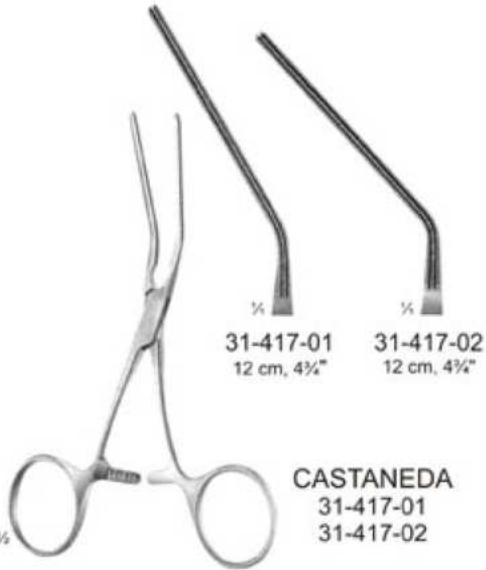



DE BAKEY
31-430-15
31-430-20



31-430-15
15 cm, 6"



31-430-20
20 cm, 8"

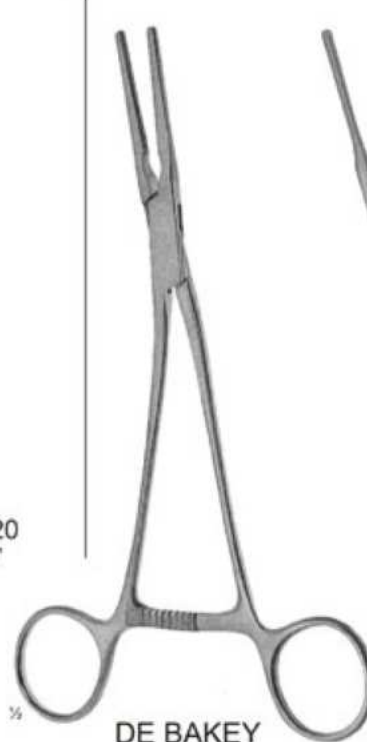

DE BAKEY
31-431-15
31-431-20



31-431-15
15 cm, 6"

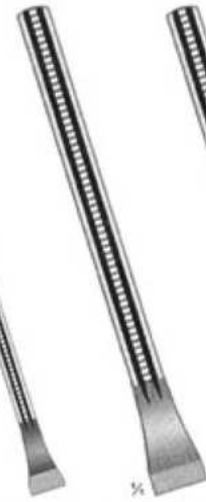

31-431-20
20 cm, 6"



31-431-23
20 cm, 9"



DE BAKEY
31-432-16
31-433-16



31-432-16
16,5 cm, 6½"



31-433-16
16 cm, 6½"



DE BAKEY-POTTS
31-434-21
31-435-21



31-434-21
21 cm, 8¼"



31-435-21
21 cm, 8¼"

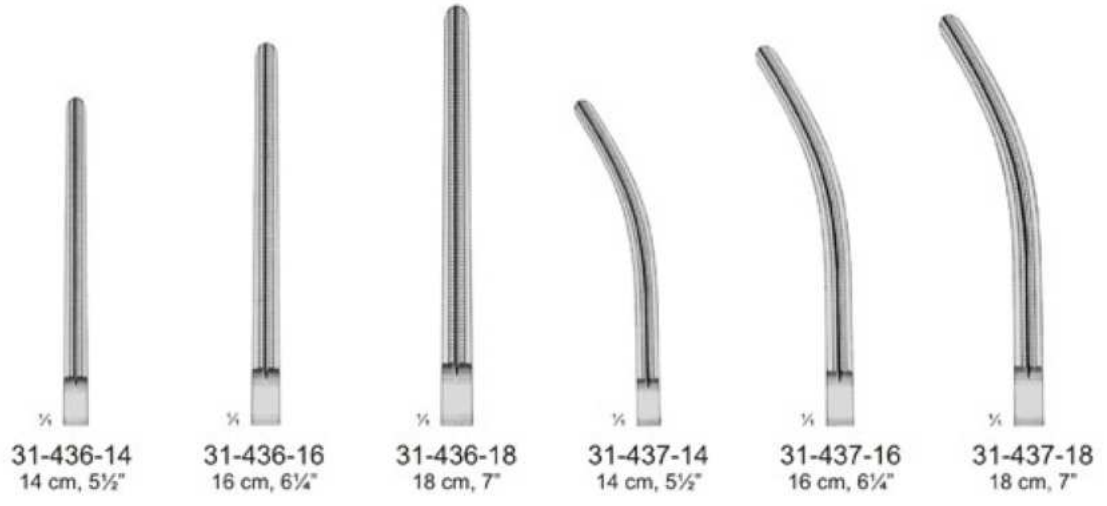

31-436-14 14 cm, 5½"	31-436-16 16 cm, 6¼"	31-436-18 18 cm, 7"	31-437-14 14 cm, 5½"	31-437-16 16 cm, 6¼"	31-437-18 18 cm, 7"
-------------------------	-------------------------	------------------------	-------------------------	-------------------------	------------------------

DE BAKEY-PEAN
 31-436-14
 31-437-18

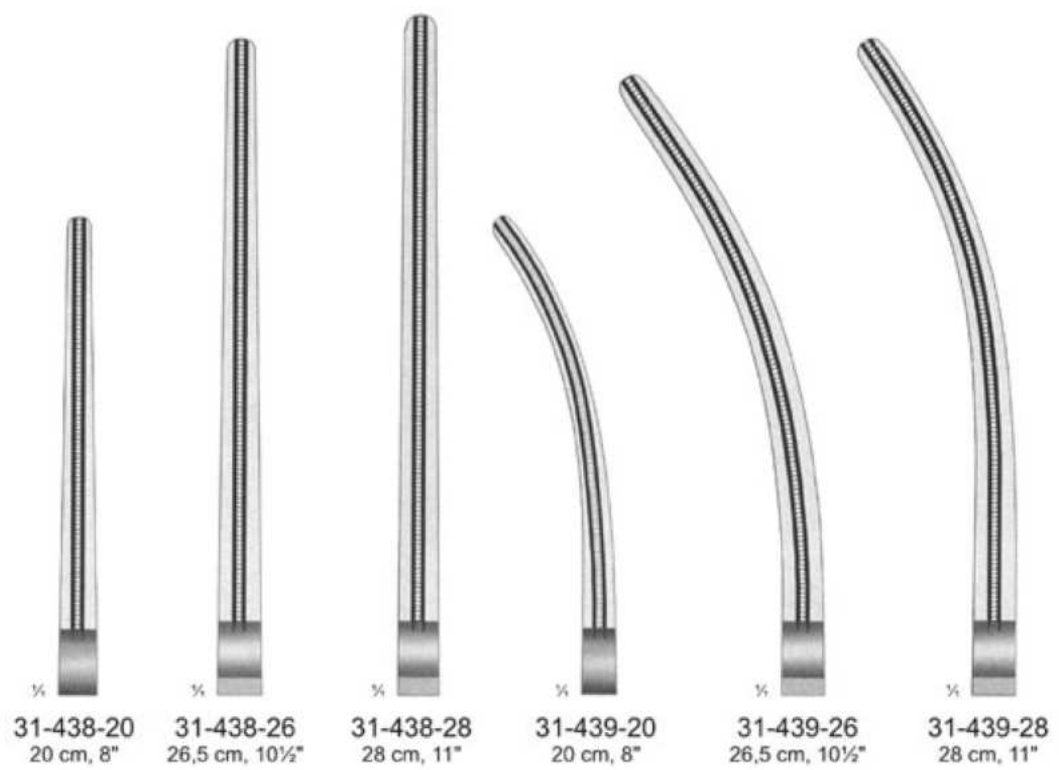

31-438-20 20 cm, 8"	31-438-26 26,5 cm, 10½"	31-438-28 28 cm, 11"	31-439-20 20 cm, 8"	31-439-26 26,5 cm, 10½"	31-439-28 28 cm, 11"
------------------------	----------------------------	-------------------------	------------------------	----------------------------	-------------------------

DE BAKEY-PEAN
 31-438-20
 31-439-28



DE BAKEY
 31-441-01
 31-441-03



31-441-01
 16 cm, 6 1/4"



31-441-02
 15 cm, 6"



31-441-03
 15 cm, 6"

Multi-purpose clamps
 Mehrzweckklemmen
 Pinzas-clamps de varias aplicaciones
 Pincas-clamps universelles
 Pinze multiuso



DARDIK
 31-450-01
 31-454-05



31-450-01
 15 cm, 6"



31-450-02
 15 cm, 6"



31-450-03
 15 cm, 6"



31-450-04
 14,5 cm, 5 1/4"



31-450-05
 13 cm, 5"



31-454-01
 16,5 cm, 6 1/2"



31-454-02
 16,5 cm, 6 1/2"



31-454-03
 16 cm, 6 1/4"



31-454-04
 16 cm, 5 1/4"

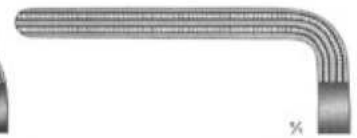

31-454-05
 13,5 cm, 5 1/4"

Peripheral Vascular Clamps with Toothing DE BAKEY

Peripheralklemmen mit DE BAKEY-Zahnung

Pinzas-clamps para vasos periféricos

Pinces-clamps vasculaires périphériques avec denture DE BAKEY

Pinze per vasi periferici con dentatura DE BAKEY

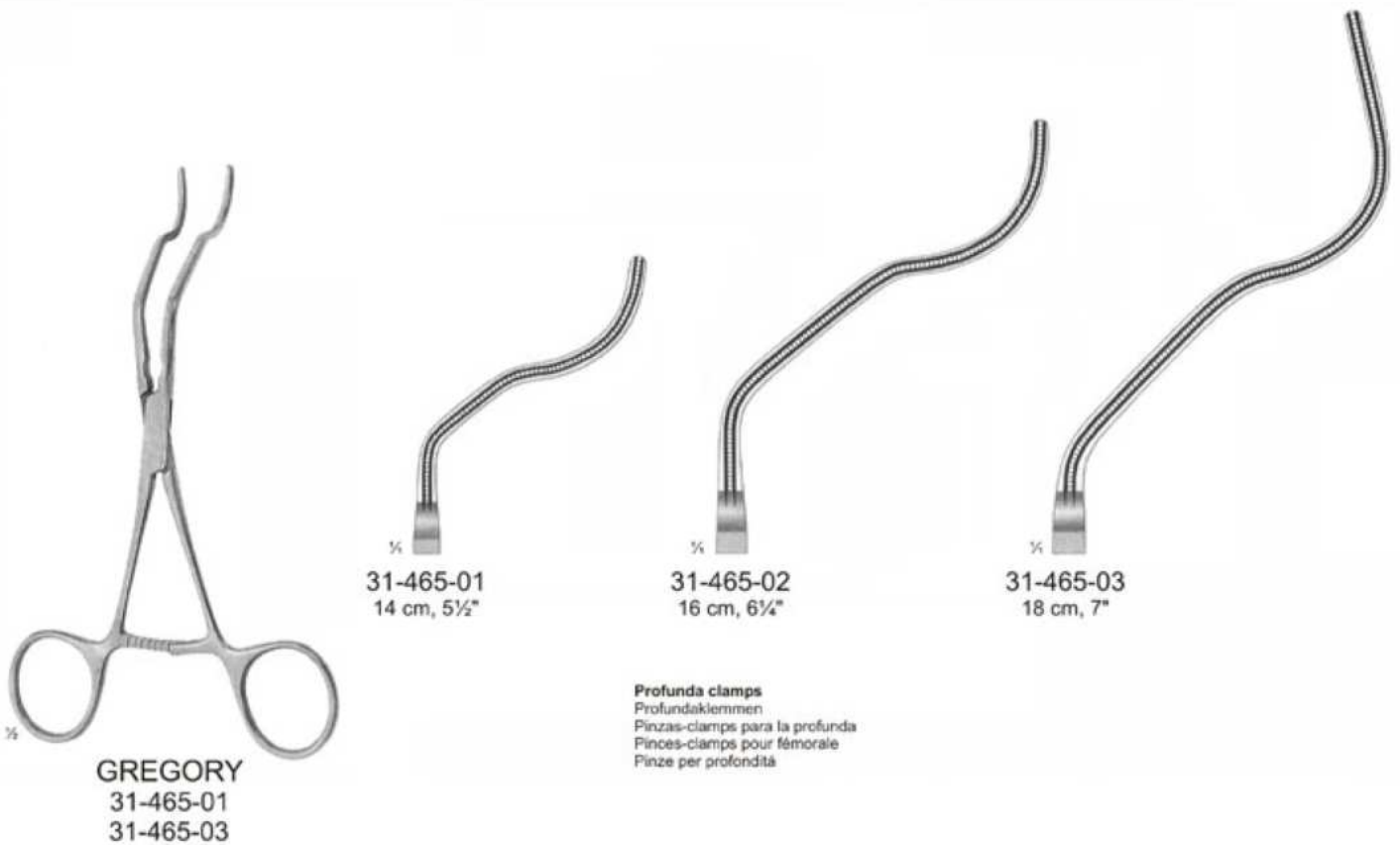
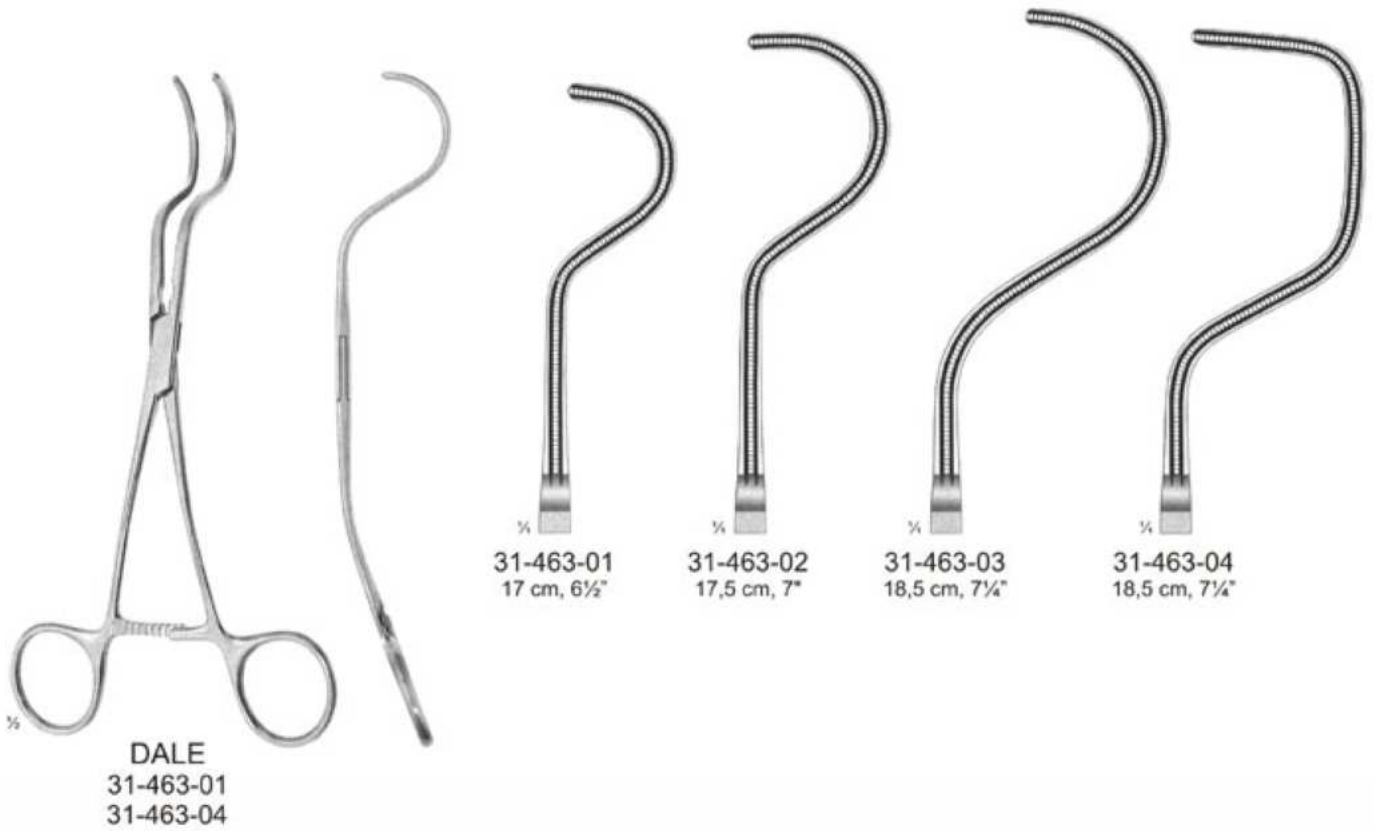

Coarctation Clamps with Toothig DE BAKE

Coarctationsklemmen mit DE BAKKEY-Zahnung
Pinzas-clamps para coarctación con dentado DE BAKKEY
Pincas-clamps pour coarctation avec denture DE BAKKEY
Pinze per coartazione con dentatura DE BAKKEY



DE BAKKEY
31-470-20
31-471-25



31-470-20 20,5 cm, 8"
31-470-22 22,5 cm, 9"
31-470-26 26 cm, 10½"



31-471-20 20 cm, 8"
31-471-22 22 cm, 8¾"
31-471-25 25,5 cm, 10"



LELAND JONES
31-475-01
31-475-02

31-475-01 20 cm, 8"
31-475-02 19 cm, 7½"

Peripheral vascular clamps
Peripheralklemmen
Pinzas-clamps para vasos periféricos
Pincas-clamps vasculaires périphériques
Pinze per vasi periferici



DE BAKKEY
31-477-18
18 cm, 7"

Peripheral Vascular Clamps with Toothing DE BAKEY

Peripheralklemmen mit DE BAKEY-Zahnung

Pinzas-clamps para vasos periféricos

Pinces-clamps vasculaires périphériques avec denture DE BAKEY

Pinze per vasi periferici con dentatura DE BAKEY



DE BAKEY
31-480-17
17 cm, 6 3/4"

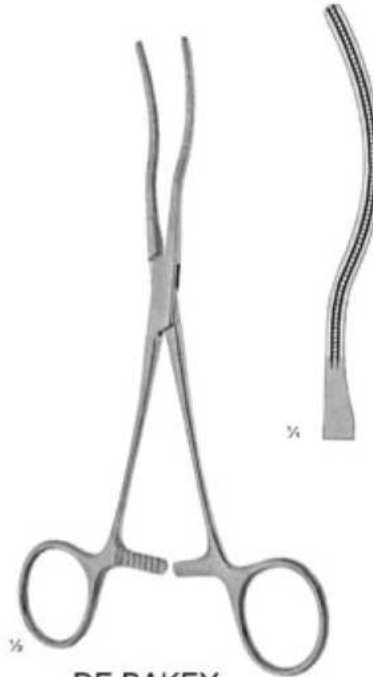

DE BAKEY
31-481-17
17 cm, 6 3/4"



DE BAKEY
31-486-16
16 cm, 6 1/4"



DE BAKEY
31-487-01
31-487-02



31-487-01
20 cm, 8"



31-487-02
19 cm, 7 1/2"

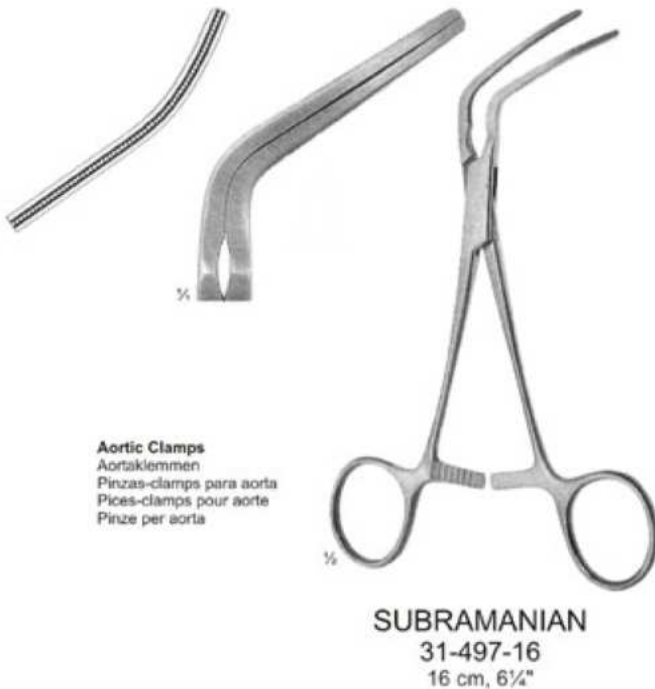
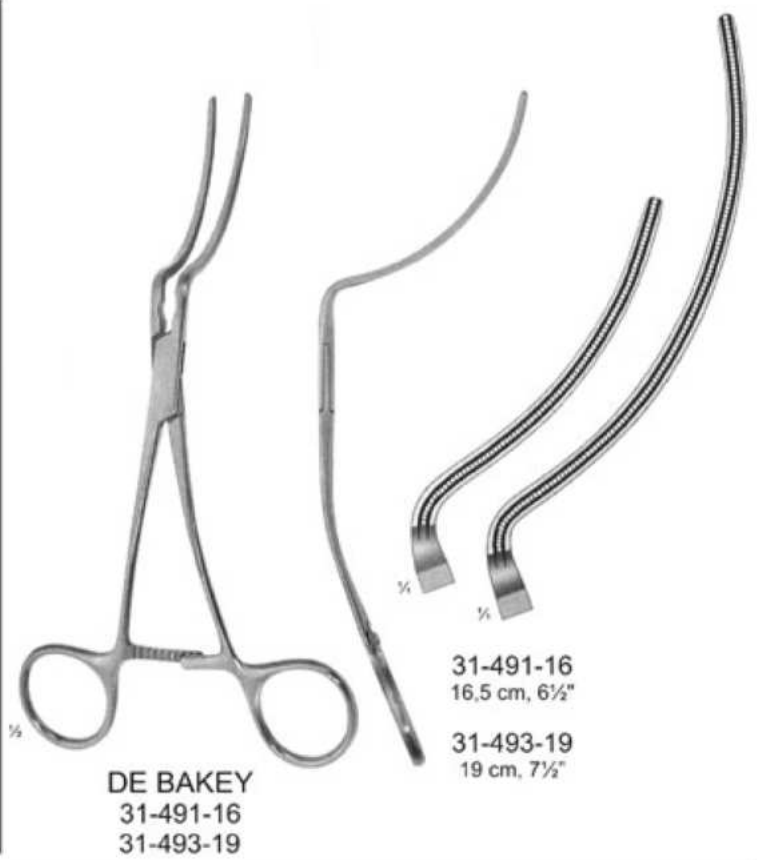
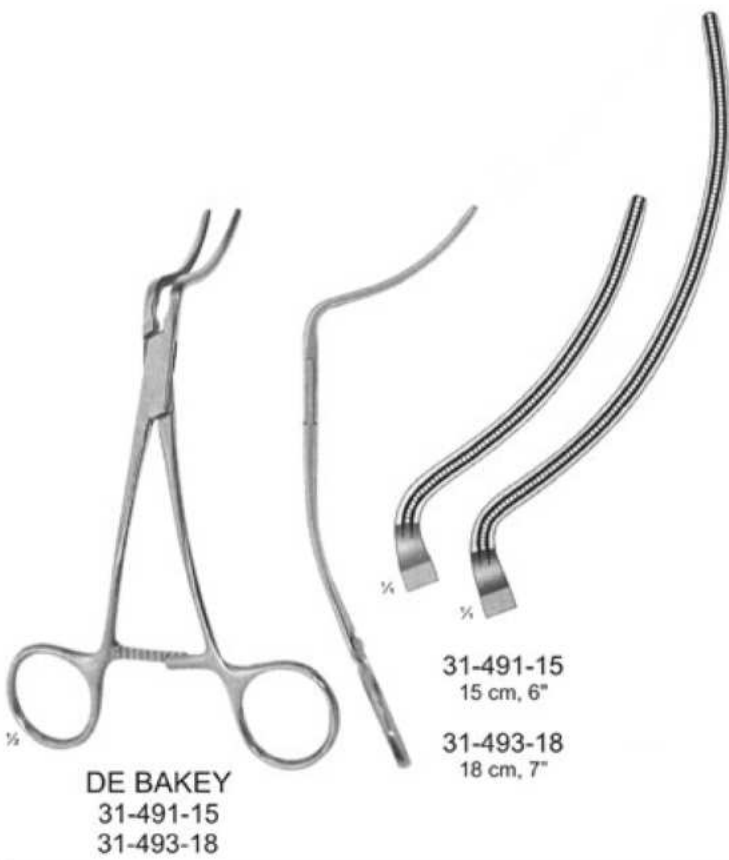

Coarctation Clamps with Tothing DE BAKEY

Coarctationsklemmen mit DE BAKEY-Zahnung
Pinzas-clamps para coarctación con dentado DE BAKEY
Pince-clamps pour coarctation avec denture DE BAKEY
Pinze per coartazione con dentatura DE BAKEY

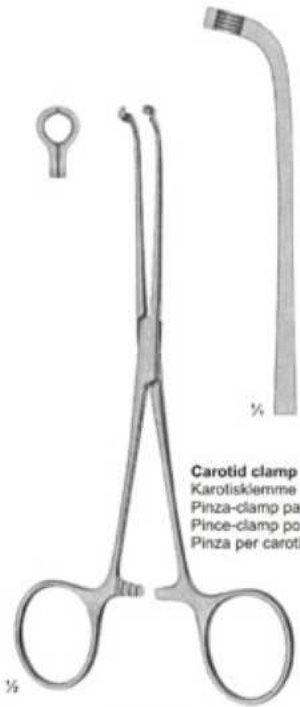

Carotid clamp
Karotisklemme
Pinza-clamp para carótida
Pince-clamp pour la carotide
Pinza per carotide

JAVID
31-500-18
18 cm, 7"

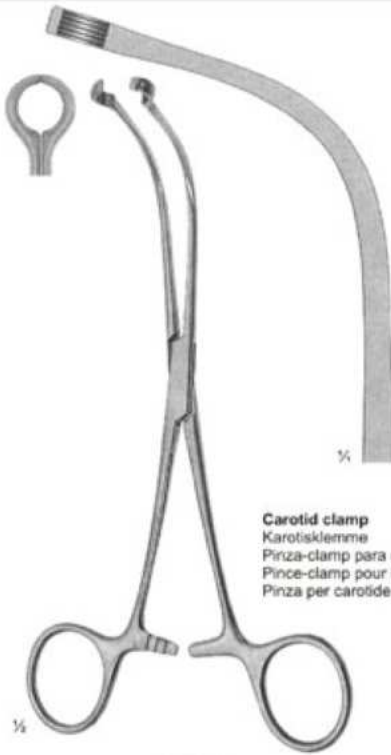

Carotid clamp
Karotisklemme
Pinza-clamp para carótida
Pince-clamp pour la carotide
Pinza per carotide

JAVID
31-506-19
19 cm, 7½"



Aortic Clamps
Aortaklemmen
Pinzas-clamps para aorta
Pices-clamps pour aorte
Pinze per aorta

DE BAKLEY-BECK
31-508-17
17 cm, 6¾"



DE BAKLEY
31-511-20
20 cm, 8"



Renal artery clamp
Nierenarterienklemme
Pinza-clamp para arteria renal
Pince hémostatique rénale
Pinza emostatica per arteria renale



BAILEY
31-516-22
31-516-23



31-516-22
22 cm, 8¾"

31-516-23
23 cm, 9"



BAILEY
 31-519-19
 31-519-23

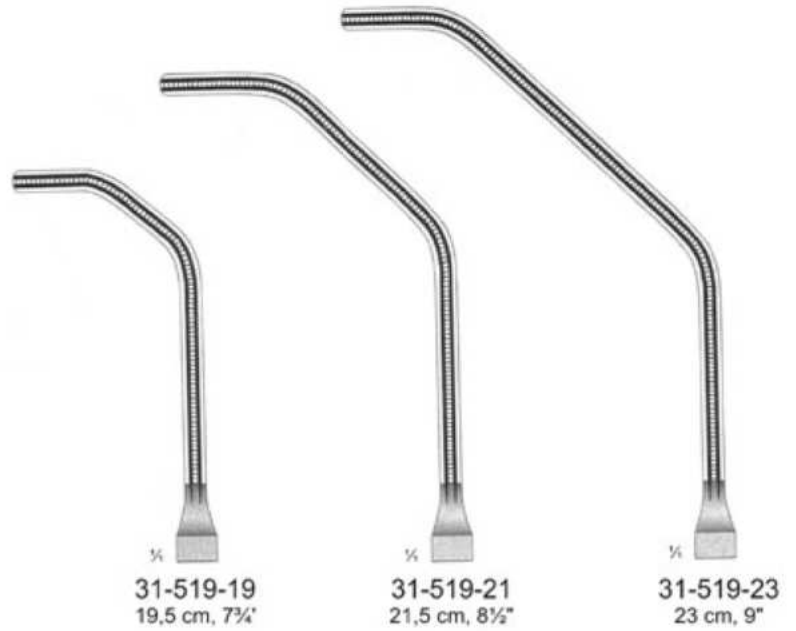

$\frac{1}{2}$
31-519-19
 19,5 cm, 7 $\frac{1}{4}$ "

$\frac{1}{2}$
31-519-21
 21,5 cm, 8 $\frac{1}{2}$ "

$\frac{1}{2}$
31-519-23
 23 cm, 9"



BAILEY
 31-529-20
 31-529-23

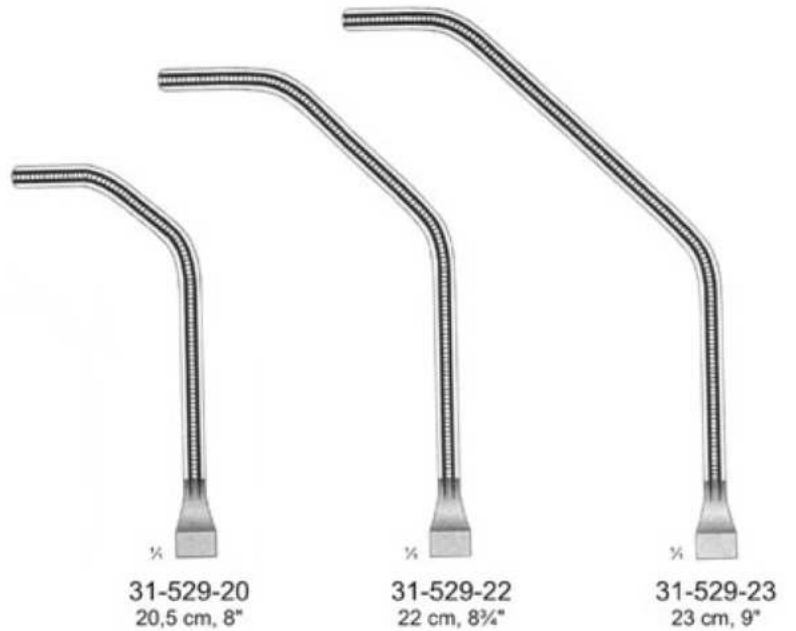

$\frac{1}{2}$
31-529-20
 20,5 cm, 8"

$\frac{1}{2}$
31-529-22
 22 cm, 8 $\frac{1}{2}$ "

$\frac{1}{2}$
31-529-23
 23 cm, 9"



DIETRICH
 31-539-21
 21 cm, 8¼"

OCHSNER
 31-539-23
 23,5 cm, 9¼"



DIETRICH
 31-539-21
 31-539-23



DE BAKEY
 31-551-27
 27 cm, 10½"



31-561-18
18 cm, 7"

31-561-20
20 cm, 8"



DE BAKEY-MORRIS
31-561-18
31-561-25

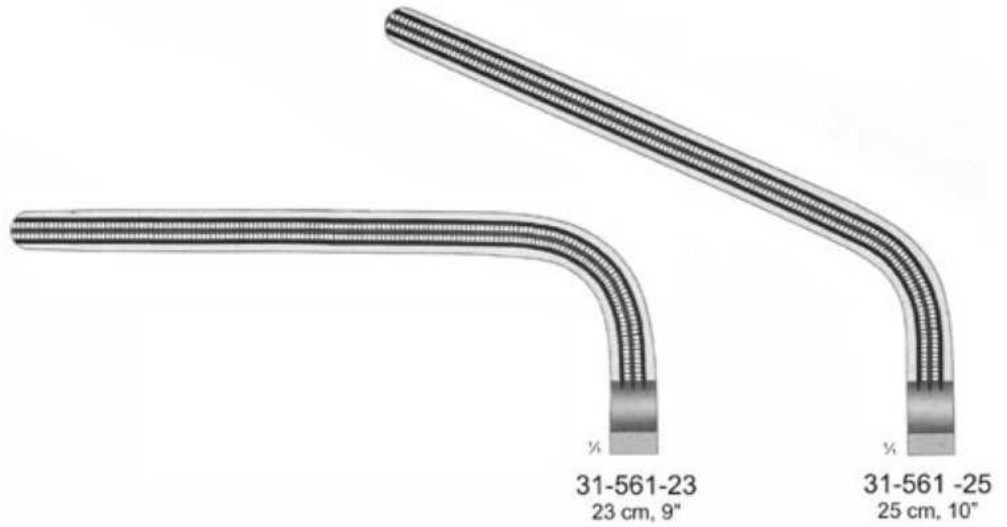

31-561-23
23 cm, 9"

31-561-25
25 cm, 10"

Tangential Occlusion Clamps

Gefäßklemmen für Tangential-Verschluss

Pinzas-clamps para oclusión tangencial

Pinces vasculaires pour occlusion tangentielle

Pinze vascolari per occlusione tangenziale



DE BAKEY
31-571-01
31-571-05

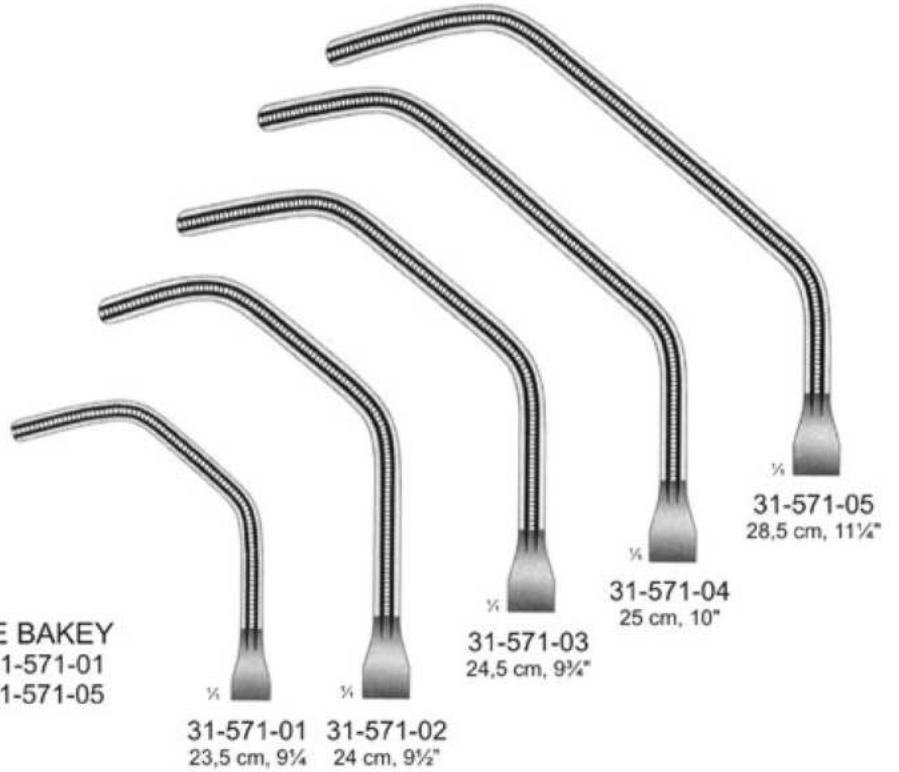

31-571-01 31-571-02
23,5 cm, 9 $\frac{1}{4}$ " 24 cm, 9 $\frac{1}{2}$ "

31-571-03
24,5 cm, 9 $\frac{3}{4}$ "

31-571-04
25 cm, 10"

31-571-05
28,5 cm, 11 $\frac{1}{4}$ "



**DE BAKEY
SATINSKY**
31-581-01
31-581-05

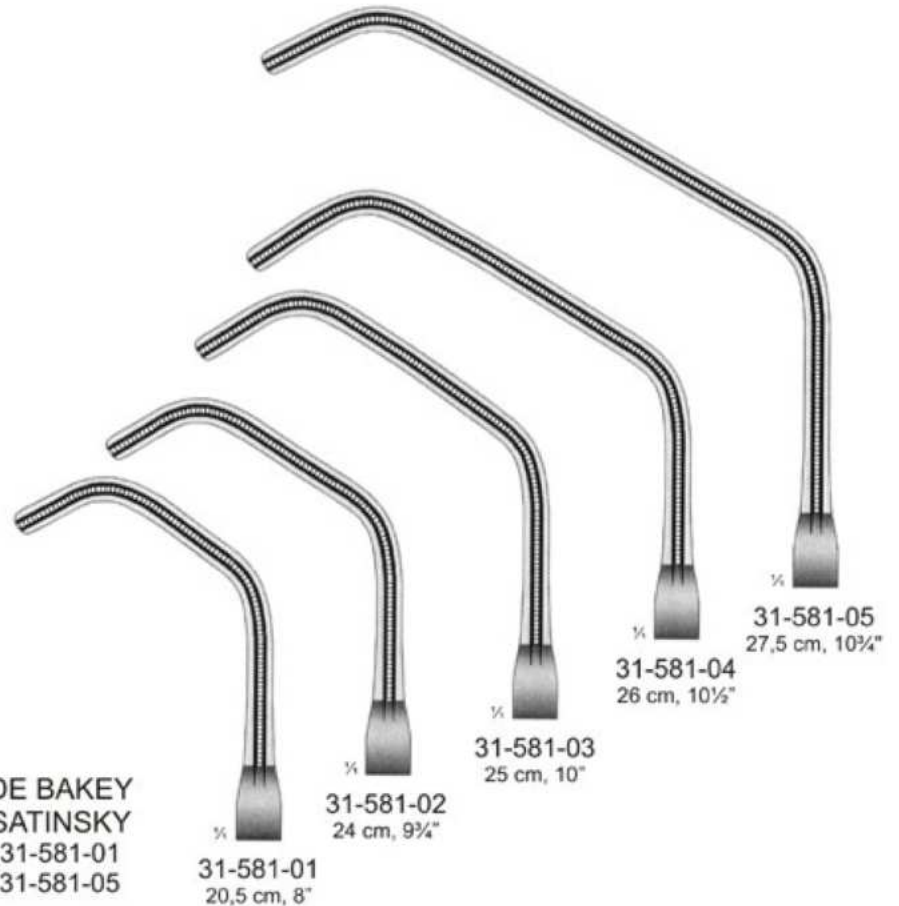

31-581-01
20,5 cm, 8"

31-581-02
24 cm, 9 $\frac{3}{4}$ "

31-581-03
25 cm, 10"

31-581-04
26 cm, 10 $\frac{1}{2}$ "

31-581-05
27,5 cm, 10 $\frac{3}{4}$ "

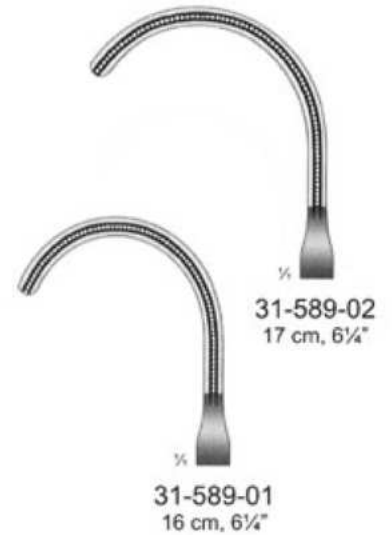
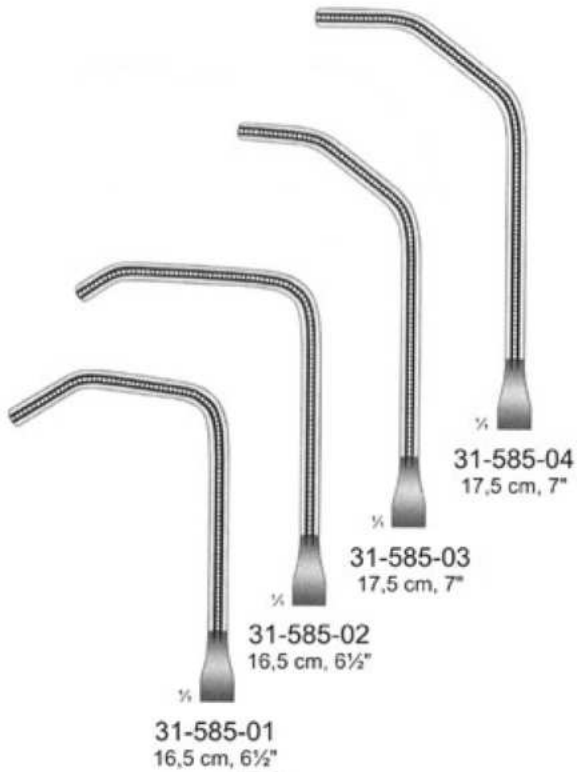

DE BAKEY-REYNOLDS
31-585-01
31-585-04



DE BAKEY-DERRA
31-587-01
31-587-03



DE BAKEY-BECK
31-589-01
31-589-02

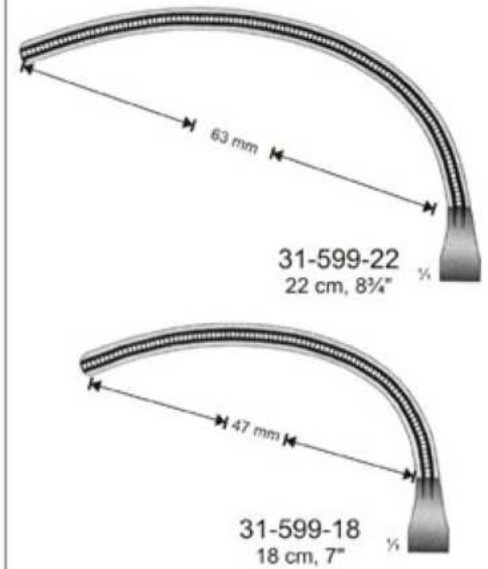



For Temporary occlusion of the arteria iliaca
 Für temporären Verschluss der Iliac-Arterie
 Para la oclusión temporal de la arteria iliac
 Pour occlusion temporaire de l'artere iliaque
 Per l'occlusione temporanea dell'arteria iliaca

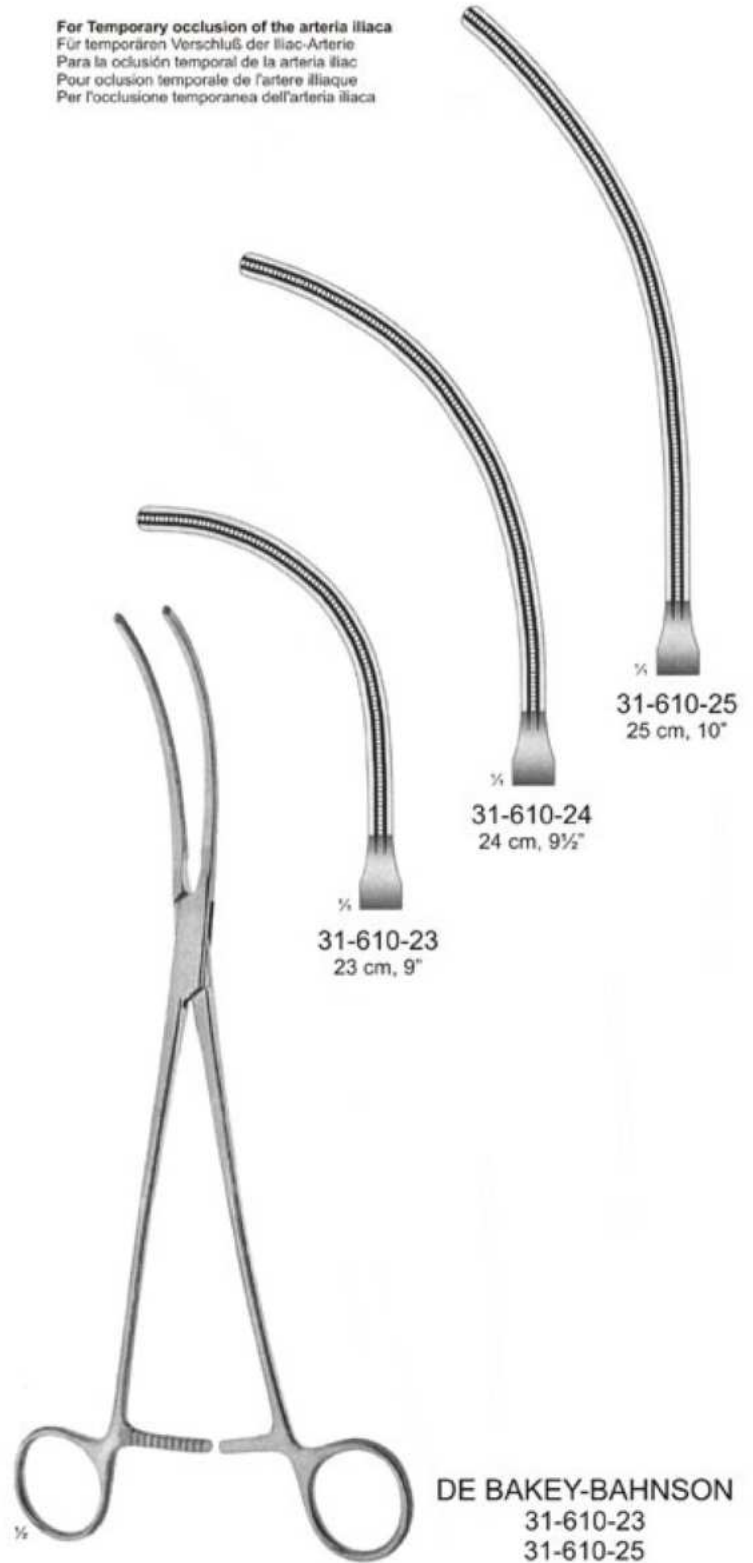

Aortic clamps with Toothing DE BAKEY

Aortaklemmen mit DE BAKEY-Zahnung
Pinzas-clamps para aorta con dentado DE BAKEY
Pincas-clamps pour aorte avec denture DE BAKEY
Pinze per aorta con dentatura DE BAKEY

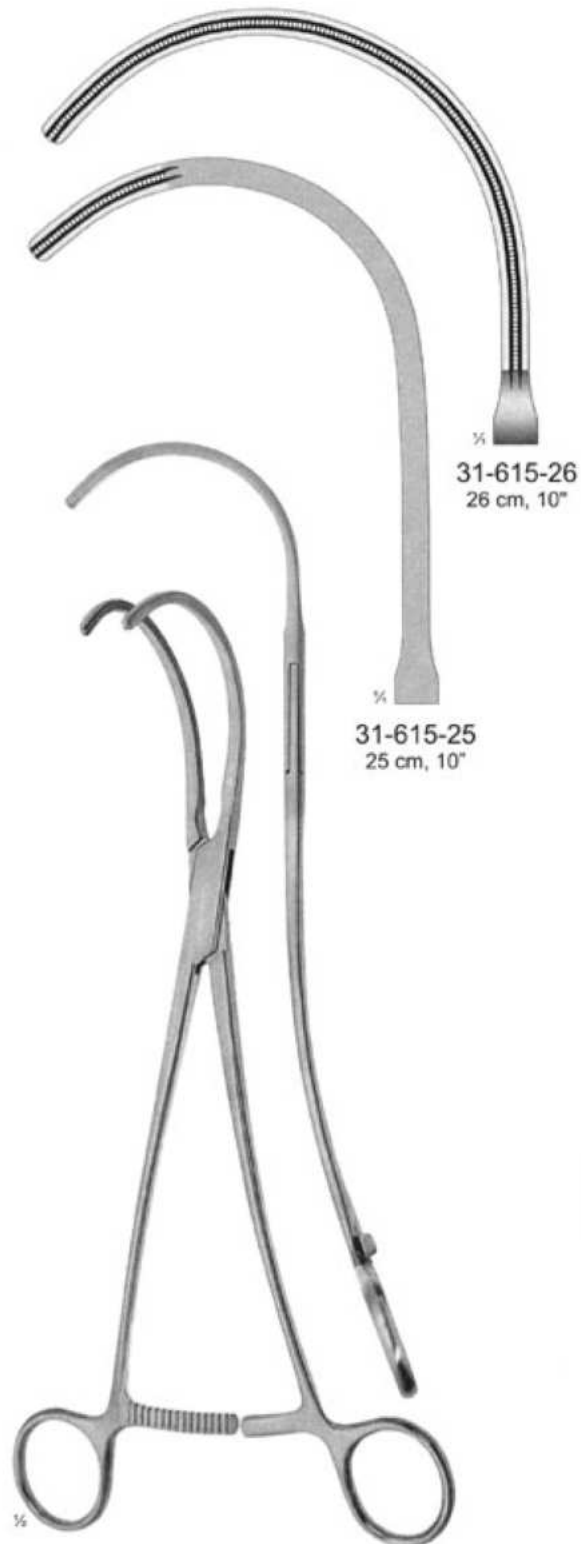

31-615-26
26 cm, 10"

31-615-25
25 cm, 10"

DE BAKEY
31-615-25
31-615-26



31-617-21
21 cm, 8 1/4"

31-617-20
20 cm, 8"

LAMBERT-KAY
31-617-20
31-617-21



31-629-23
23,5 cm, 9¼"

31-629-25
25,5 cm, 10"

31-629-26
26 cm, 10¼"

DE BAKEY-CRAFOORD
31-629-23
31-629-26



DE BAKEY-CRAFOORD
31-631-26
26 cm, 10¼"



DE BAKEY
 31-645-30
 30 cm, 11 1/4"



31-641-26
 26 cm, 10 1/4"

31-641-27
 27 cm, 10 1/2"

31-641-31
 31 cm, 12 1/4"

31-641-33
 33 cm, 13"

DE BAKEY
 31-641-26
 31-641-33



DE BAKEY
 31-651-01
 31-651-06

Dissecting and Ligature Forceps with Tothing DE BAKEY
 Präparier- und Ligaturklemmen mit BAKEY-Zahnung
 Pinzas para disección y ligaduras con dentado DE BAKEY
 Pincers à disséquer et à ligatures avec denture DE BAKEY
 Pinze per dissezione e legature con dentatura DE BAKEY

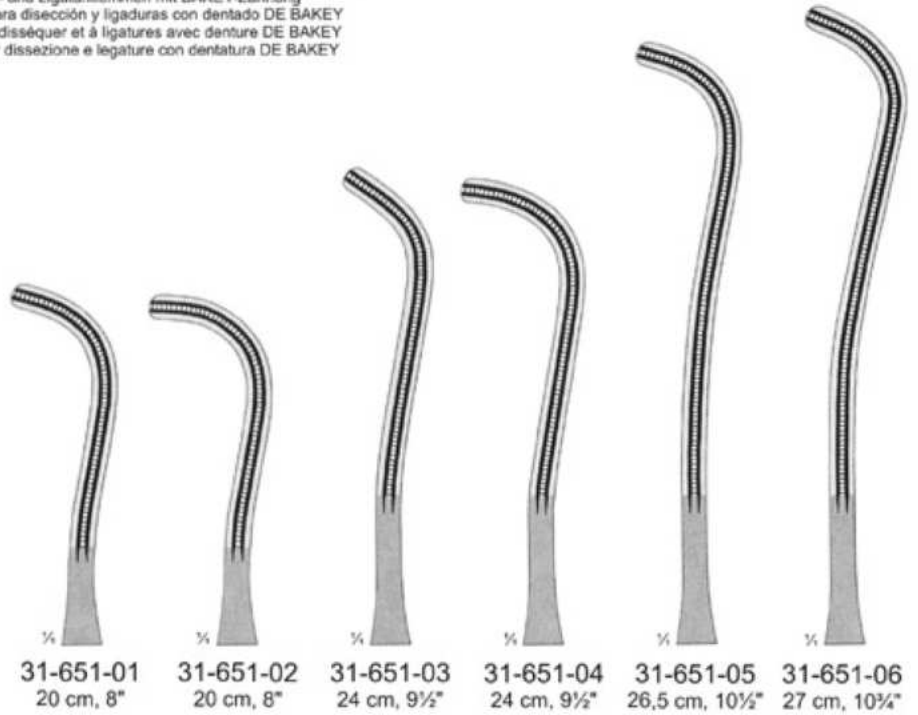

31-651-01
 20 cm, 8"

31-651-02
 20 cm, 8"

31-651-03
 24 cm, 9½"

31-651-04
 24 cm, 9½"

31-651-05
 26,5 cm, 10½"

31-651-06
 27 cm, 10½"



31-671-19
 19 cm, 7½"

31-671-21
 21 cm, 8¼"

DE BAKEY-BECK
 31-671-19
 31-671-21



31-677-23
 23 cm, 9"

31-677-22
 22,5 cm, 9"

WYLIE
 31-677-22
 31-677-23



Aorta-Anastomosis clamps with Toothing DE BAKEY
 Aorta-Anastomosenklemmen mit DE BAKEY-Zahnung
 Pinzas-clamps para anastomosis de aorta con dentado DE BAKEY
 Pincos-clamps à anastomose de l'aorte avec denture DE BAKEY
 Pinze per l'anastomosi dell'aorta con dentatura DE BAKEY

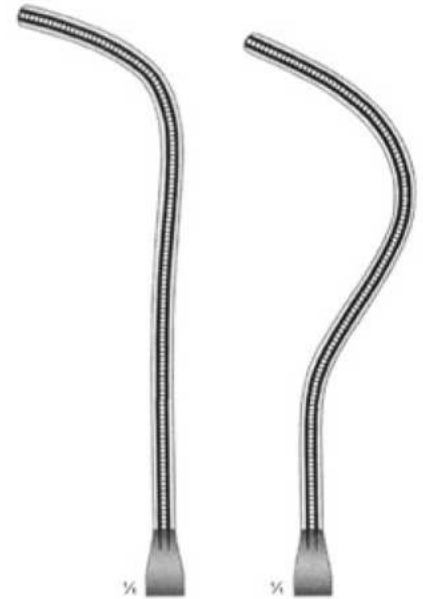

31-685-24
24 cm, 9 1/4"

31-687-24
24 cm, 9 1/2"



WEBER Left
Links
Izquierda
à gauche
sinistra
31-681-26
26 cm, 10 1/4"

WEBER Right
Rechts
Derecha
à droite
Destra
31-683-26
26 cm, 10 1/4"



DE BAKEY-HARKEN
31-685-24
31-687-24

Bronchus Clamps with Toothing DE BAKEY

Bronchusklemmen mit DE BAKEY-Zahnung
Pinzas-clamps bronquiales con dentado DE BAKEY
Pinces-clamps à bronches avec denture DE BAKEY
Pinze per bronchi con dentatura DE BAKEY

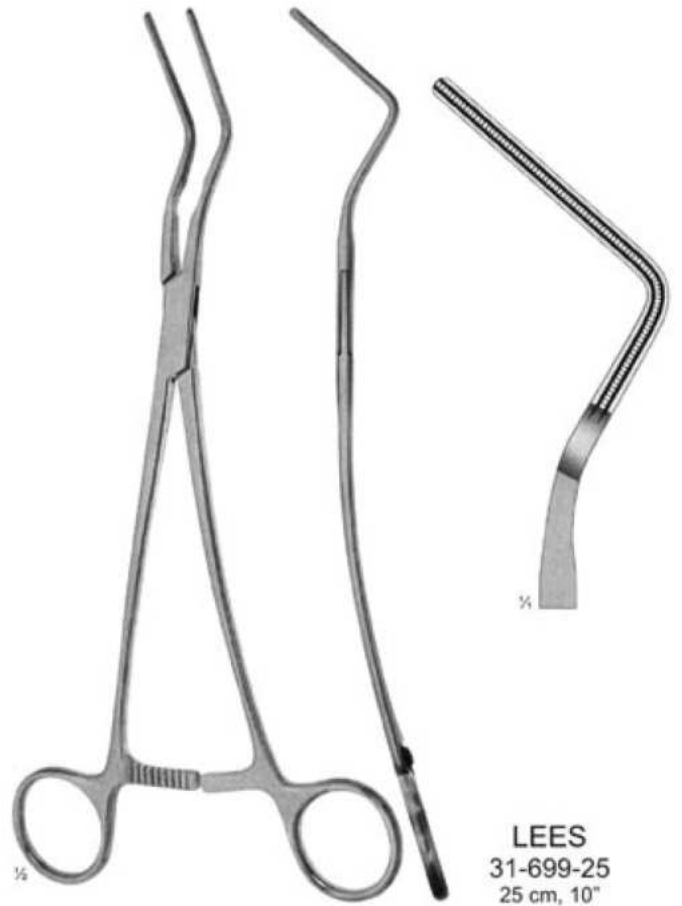

Multi-Purpose Clamps with Toothing DE BAKEY

Mehrzweckklemmen mit DE BAKEY-Zahnung

Pinzas-clamps de varieas aplicaciones con dentado DE BAKEY

Pinces-clamps universelles avec denture DE BAKEY

Pinze multiuso con dentatura DE BAKEY



031

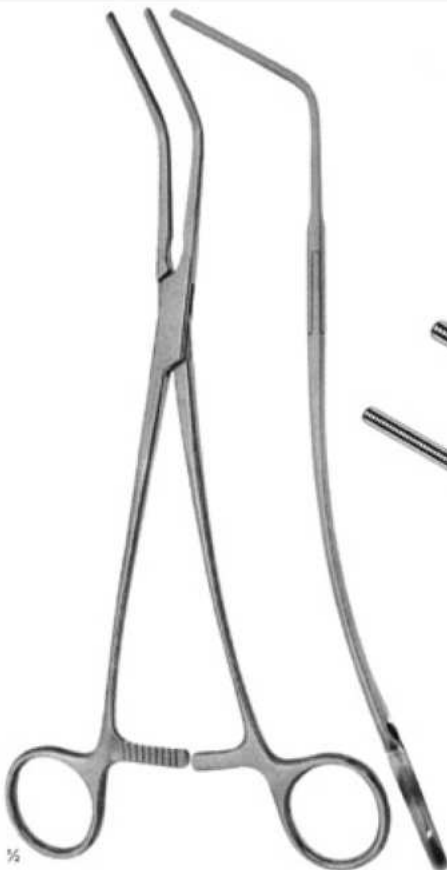
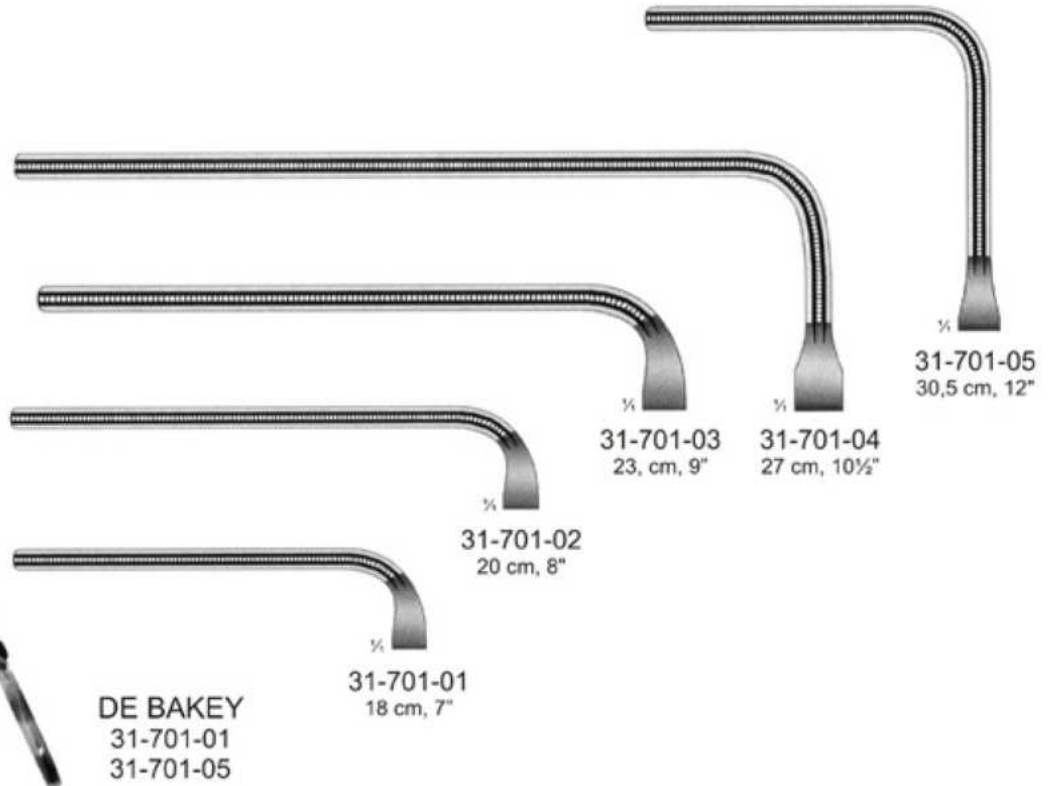
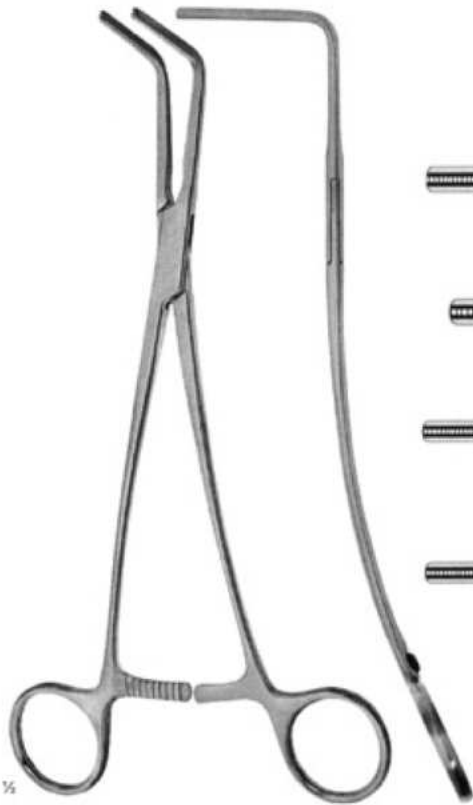



31-710-14
14 cm, 5½"

31-711-14
14 cm, 5½"

COOLEY
31-710-14
31-711-14

For pediatric surgery
Für kinderchirurgie
Para la pediatría
Pour chirurgie Pédiatrique
Per chirurgia pediatrica

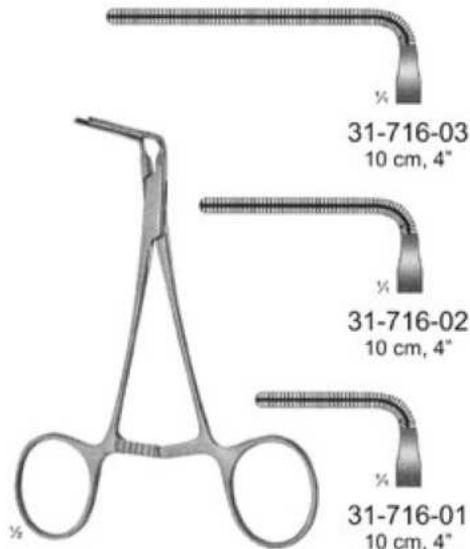

31-716-03
10 cm, 4"

31-716-02
10 cm, 4"

31-716-01
10 cm, 4"

COOLEY
31-716-01
31-716-03

For pediatric surgery
für kinderchirurgie
Para la pediatría
Pour chirurgie Pédiatrique
Per chirurgia pediatrica



COOLEY
31-721-14
14 cm, 5½"

For pediatric surgery
für kinderchirurgie
Para la pediatría
Pour chirurgie Pédiatrique
Per chirurgia pediatrica



COOLEY
31-725-14
14 cm, 5½"

For pediatric surgery
für kinderchirurgie
Para la pediatría
Pour chirurgie Pédiatrique
Per chirurgia pediatrica



COOLEY
31-729-14
14 cm, 5½"

For pediatric surgery
für kinderchirurgie
Para la pediatría
Pour chirurgie Pédiatrique
Per chirurgia pediatrica



31-731-01
12,5 cm, 5"

31-731-02
12,5 cm, 5"

COOLEY
31-731-01
31-731-02

Bulldog clamp
Bulldogklemme
Clamp Bulldog
Clamp Bulldog
Pinza Bulldog



COOLEY
 31-734-15
 15 cm, 6"

Patent ductus clamp
 Patent-Ductusklemme
 Pinza patente de conducto
 Clamp patent-ductus droit
 Clamp patent per dotto



COOLEY
 31-735-15
 15 cm, 6"

Patent ductus clamp
 Patent-Ductusklemme
 Pinza patente de conducto
 Clamp patent-ductus droit
 Clamp patent per dotto



31-745-03
 15 cm, 6"



31-745-02
 15,5 cm, 6 1/4"



31-745-01
 17 cm, 6 3/4"



COOLEY
 31-736-17
 17 cm, 6 3/4"



COOLEY
 31-737-17
 17 cm, 6 3/4"



COOLEY
 31-745-01
 31-745-03

Multi-purpose clamps
 Mehrzweckklemmen
 Pizas-clamps de varias aplicaciones
 Pincas-clamps universelles
 Pinze multuso

Coarctation Clamps with Tothing COOLEY

Coarctationsklemmen mit COOLEY-Zahnung
Pinzas-clamps para coarctación con dentado COOLEY
Pincés-clamps pour coarctation avec denture COOLEY
Pinze per coartazione con dentatura COOLEY

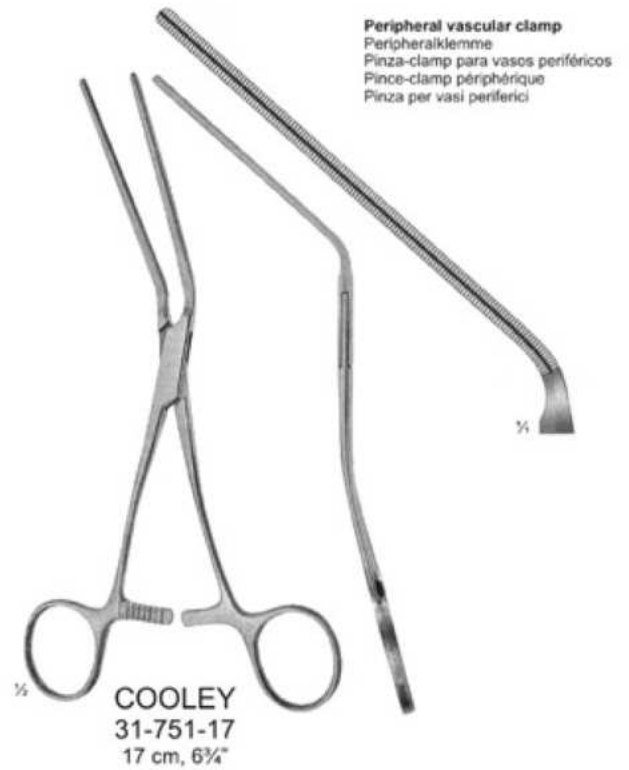
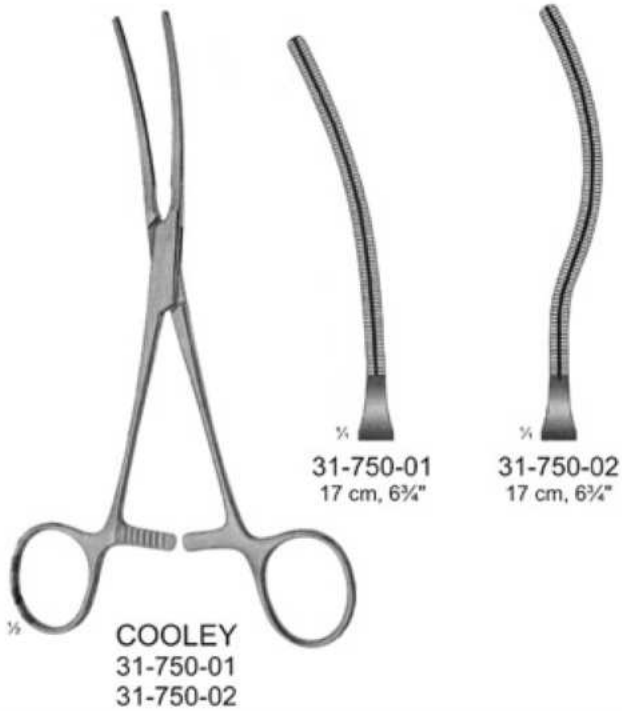



31-767-21
21 cm, 8 $\frac{1}{4}$ "

31-769-27
27 cm, 10 $\frac{1}{4}$ "



31-771-18
18,5 cm, 7 $\frac{1}{4}$ "

31-771-19
19,5 cm, 7 $\frac{3}{4}$ "

31-771-27
27,5 cm, 10 $\frac{3}{4}$ "

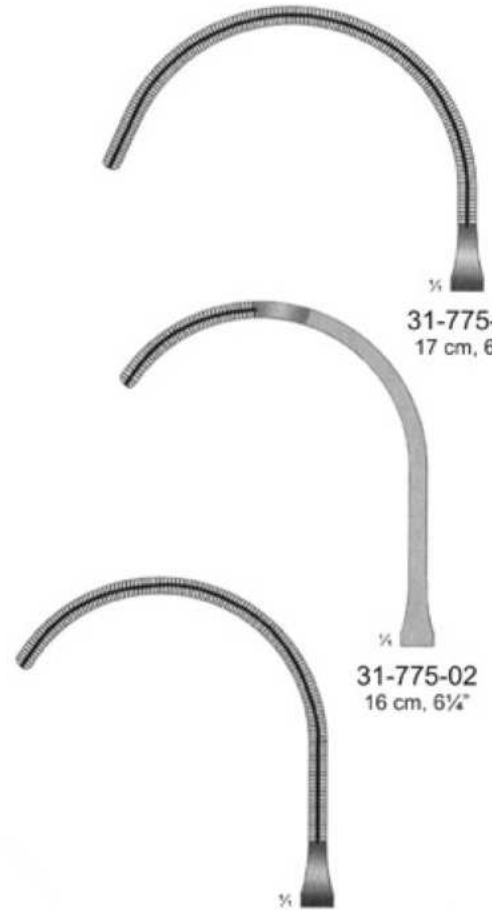

31-775-03
17 cm, 6 $\frac{1}{4}$ "

31-775-02
16 cm, 6 $\frac{1}{4}$ "

31-775-01
16 cm, 6 $\frac{1}{4}$ "



COOLEY
31-767-21
31-769-27



COOLEY
31-771-18
31-771-27



COOLEY
31-775-01
31-775-03



31-776-01
16.5 cm, 6½"



31-776-02
16 cm, 6¼"



31-776-03
15 cm, 6"



31-776-04
15 cm, 6"



31-776-05
15.5 cm, 6"



31-780-01
14 cm, 5½"



31-781-01
14 cm, 5½"



31-781-02
14 cm, 5½"



31-781-03
13 cm, 5"



31-781-04
14 cm, 5½"



31-781-05
13 cm, 5"



31-781-06
13 cm, 5"



31-781-07
14 cm, 5½"



31-781-08
13.5 cm, 5½"



31-780-01
31-781-08



COOLEY
31-783-17
 17 cm, 6½"



COOLEY-REYNOLDS
31-785-01
31-785-04

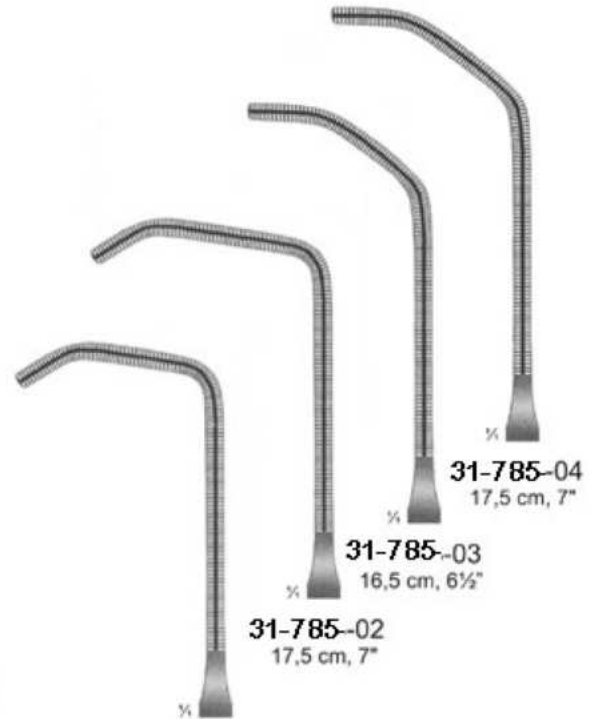

31-785-01
 16,5 cm, 6½"

31-785-03
 16,5 cm, 6½"

31-785-04
 17,5 cm, 7"

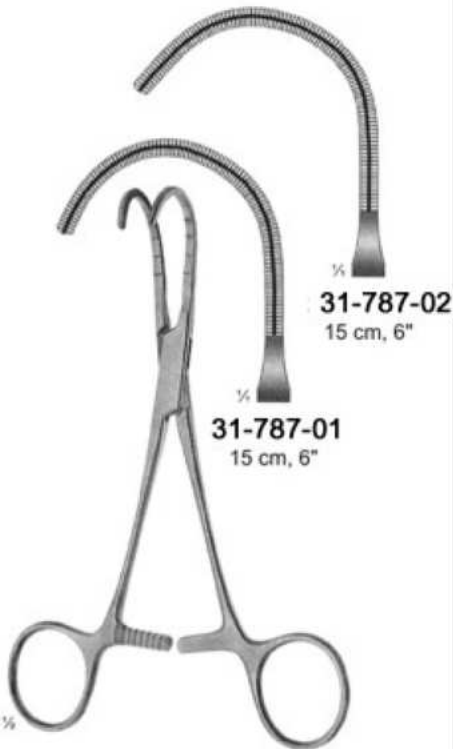

COOLEY-BECK
31-787-01
31-787-02

31-787-02
 15 cm, 6"

31-787-01
 15 cm, 6"



COOLEY-DERRA
31-789-01
31-789-03



31-789-01
 16,5 cm, 6½"

31-789-02
 16,5 cm, 6½"

31-789-03
 17 cm, 6¾"

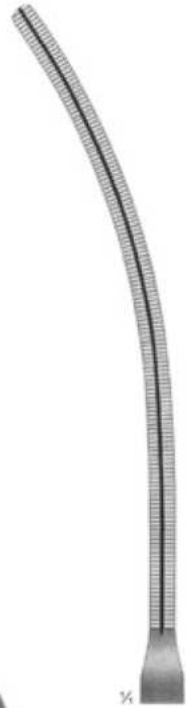

Aortic aneurysma clamp
 Aorta-Aneurysmaklemme
 Pinza-clamp para aneurisma de aorta
 Pince-clamp pour anévrisme de l'aorte
 Pinza per l'aneurisma dell'aorta



COOLEY
 31-790-26
 26 cm, 10 1/4"

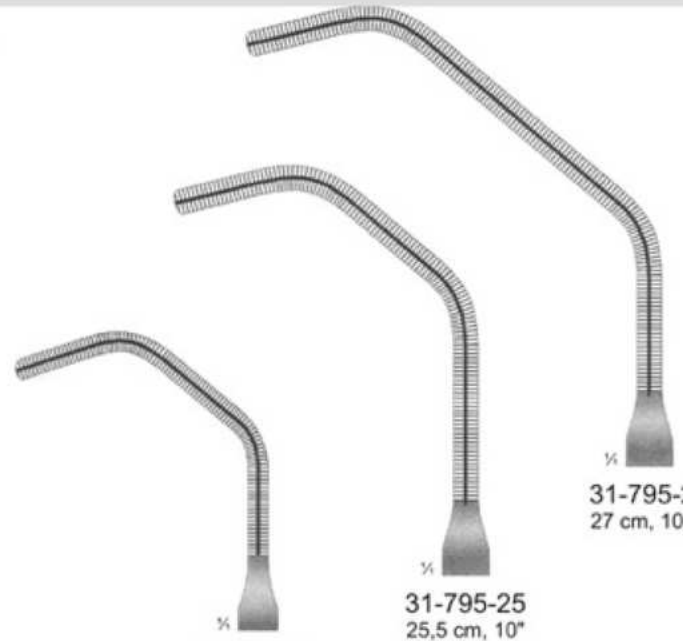

31-795-19
 19 cm, 7 1/2"

31-795-25
 25,5 cm, 10"

31-795-27
 27 cm, 10 1/4"

Tangential occlusion clamps
 Gefäßklemmen für Tangential-Verschluss
 Pinzas-clamps para oclusión tangencial
 Pincas-clamps pour occlusion tangentielle
 Pinze per occlusione tangenziale



COOLEY
 31-795-19
 31-795-27

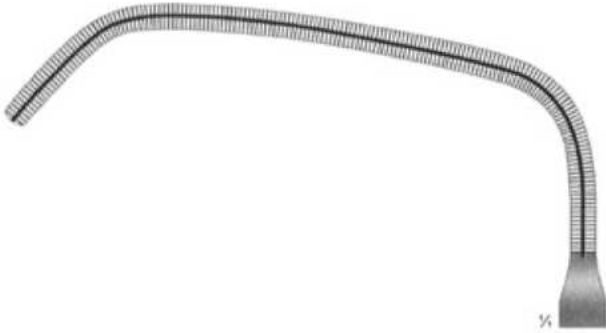

31-799-23
23,5 cm, 9¼"



31-799-20
20 cm, 8"



COOLEY
31-797-25
25 cm, 10"

Aortic clamp
 Aortaklemme
 Pinza-clamp para aorta
 Pince-clamp pour aorte
 Pinza per aorta



COOLEY
31-799-20
31-799-23

Multi-purpose clamps
 Mehrzweckklemmen
 Pinzas-clamps de varias aplicaciones
 Pincas-clamps universelles
 Pinze multiuso

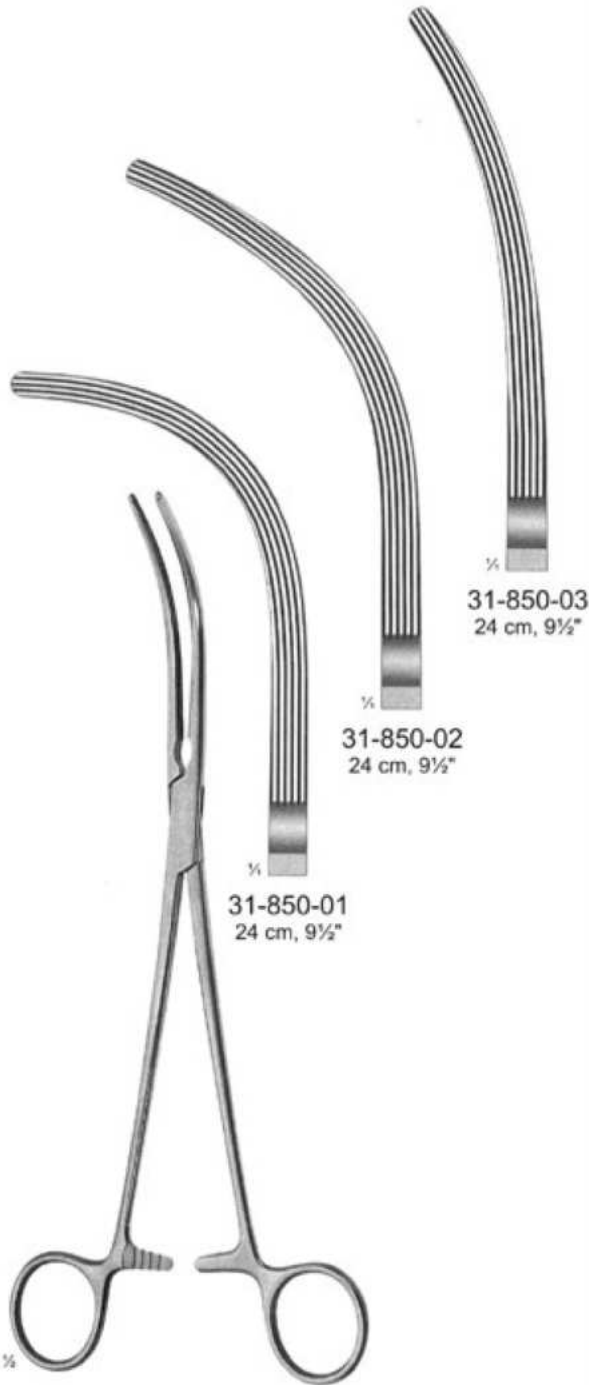

31-850-01
24 cm, 9½"

31-850-02
24 cm, 9½"

31-850-03
24 cm, 9½"

CRAFOORD
31-850-01
31-850-03

Auricle clamps
 Aurikeklemmen
 Pinzas para la aurícula atril
 Pinces-clamps auriculaires
 Pinze ventricolari

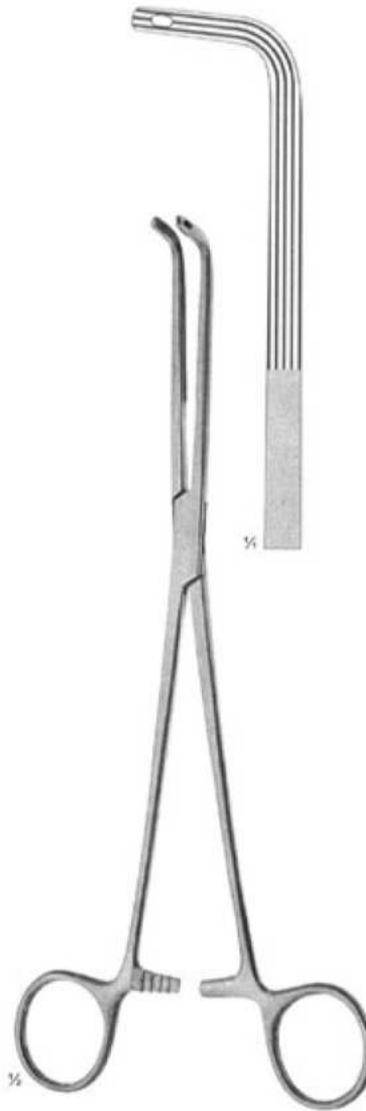

FINOCCHIETTO
31-856-24
24 cm, 9½"

Thoracic and ligature forceps
 Thorax- und Ligaturklemme
 Pinza de torácica y ligadura
 Pince thoracique et pour ligatures
 Pinza per torace e legature

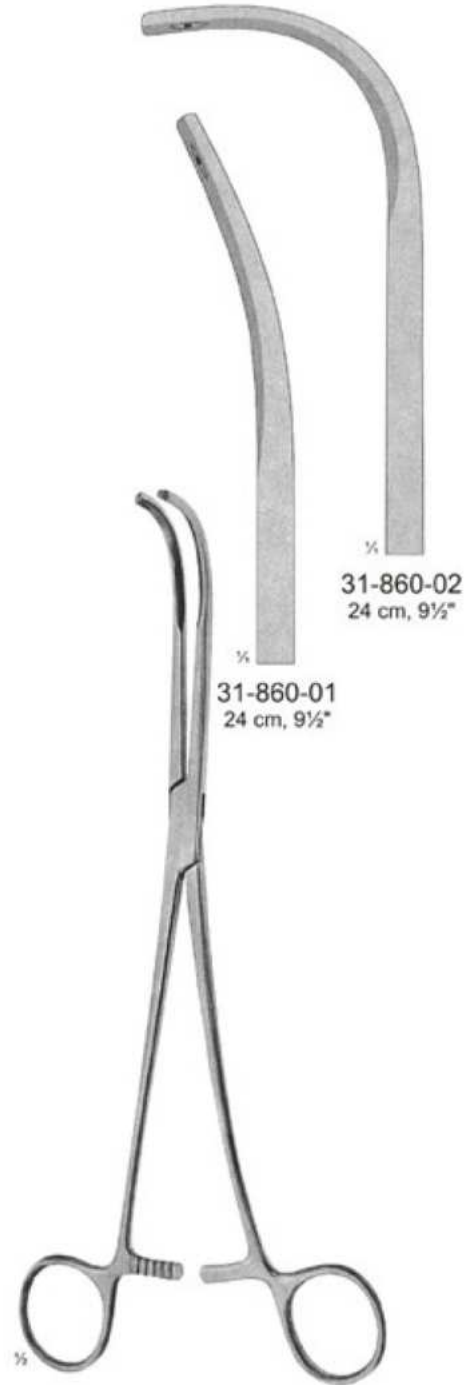

31-860-01
24 cm, 9½"

31-860-02
24 cm, 9½"

SEMEB
31-860-01
31-860-02

Dissecting and Ligature Forceps
 Präparier- und Ligaturklemmen
 Pinzas de disección y ligaduras
 Pinces à disséquer et à ligatures
 Pinze per dissezione e legature

Anastomosis (Vena Cava) Clamps
 Anastomosen (Vena cava) klemme
 Pinzas-clamps para anastomosis (vena cava)
 Pincés-clamps à anastomose (veine cave)
 Pinze per anastomosi (vena cava)



031



1/4

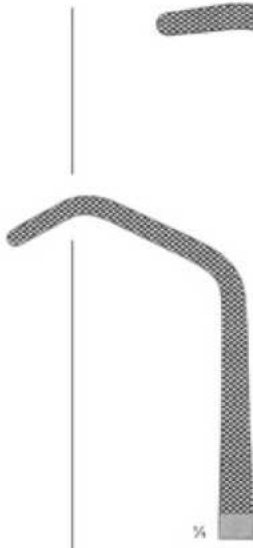

1/4

31-910-01
20,5 cm, 8"

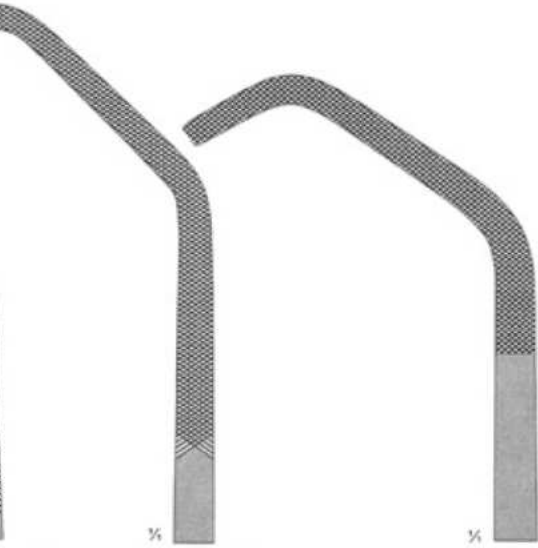

1/4

31-910-02
27,5 cm, 10 3/4"

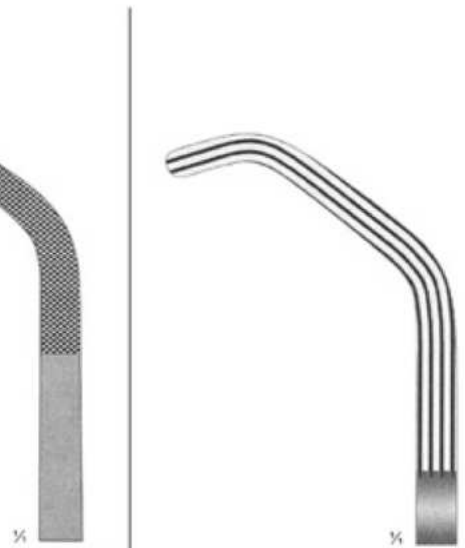

1/4

31-910-03
24 cm, 9 1/4"



Bronchus Forceps
 Bronchusklemmen
 Pinzas-clamps
 Pincés-clamps à bronches
 Pinze per legature



1/4

BABY-SATINSKY
 31-900-16
 16 cm, 6 1/4"



1/4

SATINSKY
 31-910-01
 31-910-03



1/4

PRICE-THOMAS
 31-920-22
 22 cm, 8 1/4"



31-931-01 31-931-02
22 cm, 8 $\frac{3}{4}$ " 22 cm, 8 $\frac{3}{4}$ "

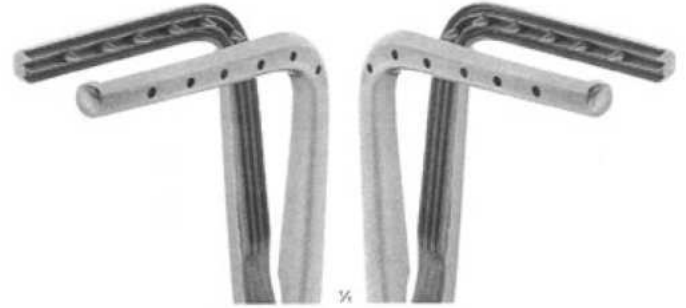

31-935-01 31-935-02
22,5 cm, 9" 22,5 cm, 9"



PRICE-THOMAS

31-931-01
31-931-02

Jaw with pins
Mit Stiften im Maul
Con dientes
Avec dents
Con denti



SAROT

31-935-01
31-935-02

Jaw with pins
Mit Stiften im Maul
Con dientes
Avec dents
Con denti