



**Gall, Liver, Kidney, Bladder, Urology**  
**Galle, Leber, Niere, Blase, Urologie**  
**Bilis, Hígado, Riñón, Vejiga, Urología**  
**Bile, Foie, Rein, Vessie, Urologie**  
**Bile, Fegato, Rene, Vescica, Urologia**



25-102-04  
ø 4,2 mm

25-102-06  
ø 6,0 mm

25-102-07  
ø 7,0 mm

**Gall duct probes flexible**

Gallengangsonden federn

Sondas para el conducto biliar, flexible

Dilatateurs à voies biliaires flexible

Dilatatore per condotti biliari flessibili

**DESJARDINS**  
25-102-04  
25-102-07  
28 cm, 11"



ø 5,0 mm

Ø 5mm

**Gall stone probe and scoop of tin, malleable**

Gallensteinsonde und -löffel aus zinn, biegsam

Sonda y cucharilla para los cálculos biliares, maleable

Sonde-curette pour vésicule biliaire, malléable

Sonda con cucchiaino per calcoli biliari, malleabile

**MOYNIHAN**  
25-106-34  
34 cm, 13½"

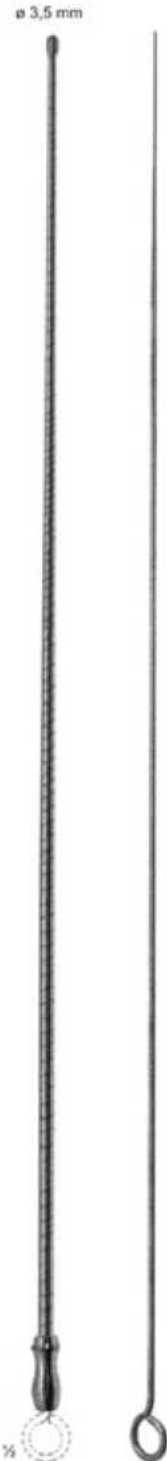

ø 3,5 mm

Ø 3.5mm

**Gall duct probes flexible**

Gallengangsonde, federn

Sonda para el conducto biliar, flexible

Dilatateur à voies biliaires flexible avec conducteur

Dilatatore per condotti biliari flessibile

**OCHSNER**  
25-108-38  
38 cm, 15¼"

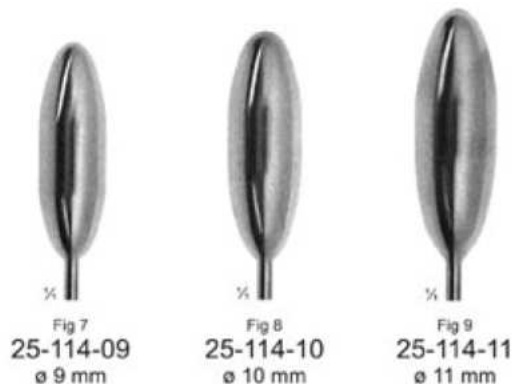
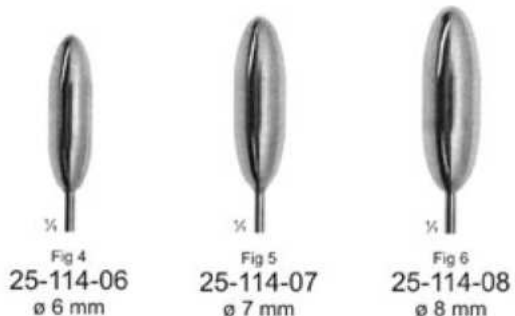
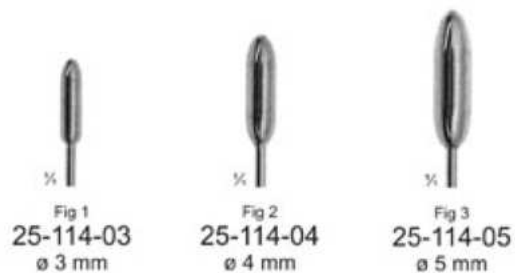

**BAKES**  
25-114-03  
25-116-11  
30 cm 12"

**BAKES**  
25-114-00  
Set , Setz , Juego , Jeu , Serie

Set of 9 common bile duct dilators 25-114-03 to 25-114-11 malleable, in plastic roll (25-114-00)

Satz von 9 Gallengang-Dilatationsölvn 25-114-03 bis 25-114-11 biegsam, in Plastiktasche (25-114-00)

Juego de 9 dilatadores para el conducto biliar del 25-114-03 al 25-114-11 maleable, en bolsa de plástico (25-114-00)

Jeu de 9 dilatateurs biliaires du 25-114-03 au 25-114-11 malléables, en sachet plastique (25-114-00)

Set di 9 dilatatori per condotti biliari dal 25-114-03 al 25-114-11 malleabili, con rotolo di plastica (25-114-00)

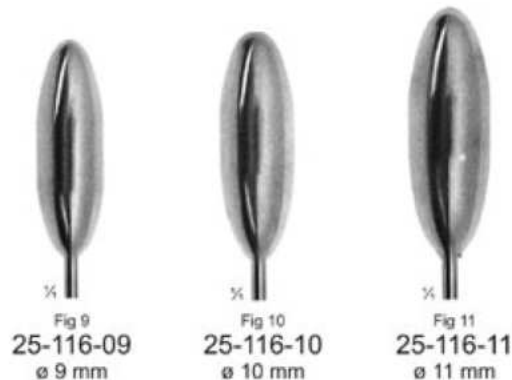
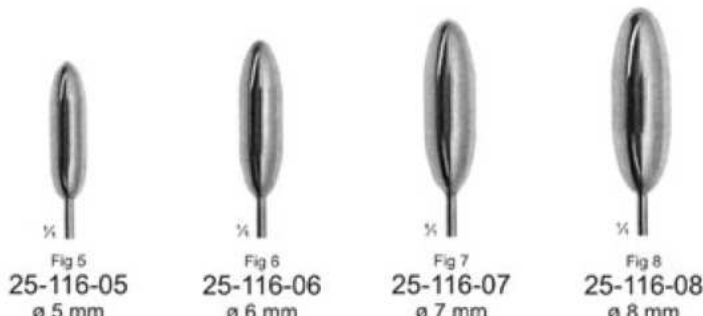
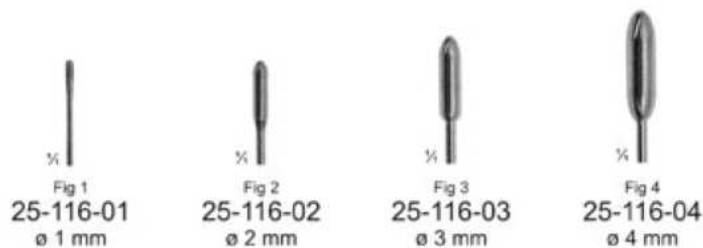

**BAKES**  
25-116-01  
25-116-13  
30 cm 12"

Fig 12  
25-116-12  
ø 12 mm

Fig 13  
25-116-13  
ø 13 mm

**BAKES**  
25-116-00

Set , Setz , Juego , Jeu , Serie

Set of 13 common bile duct dilators 25-116-01 to 25-116-13 malleable, in plastic roll (25-116-00)

Satz von 13 Gallengang-Dilatationsölvn 25-116-01 bis 25-116-13 biegsam, in Plastiktasche (25-116-00)

Juego de 13 dilatadores para el conducto biliar del 25-116-01 al 25-116-13 maleable, en bolsa de plástico (25-116-00)

Jeu de 13 dilatateurs biliaires du 25-116-01 au 25-116-13 malléables en sachet plastique (25-116-00)

Set di 13 dilatatori per condotti biliari dal 25-116-01 al 25-116-13 malleabili, con rotolo di plastica (25-116-00)

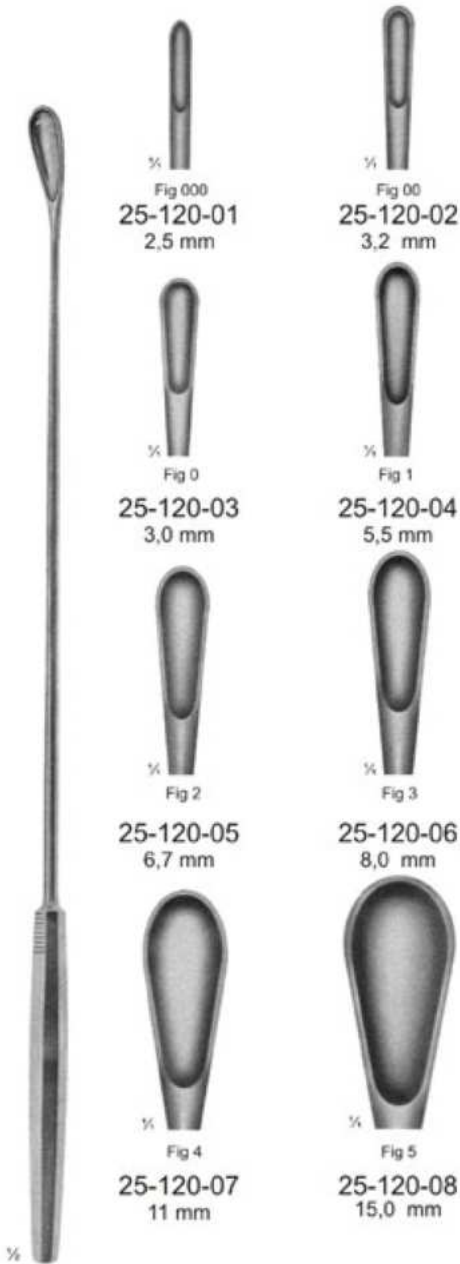

**LUER-KOERTE**  
25-120-01  
25-120-08  
32 cm, 12 $\frac{1}{4}$ "

**Gall stone scoops, malleable**  
Gallensteinlöffel, biegsam  
Cucharillas para los cálculos biliares, maleable  
Curettes pour calculs biliaires, malléables  
Cucchiai per calcoli biliari, malleabili



**MAYO**  
25-124-28  
28 cm, 11"

**Gall stone scoops**  
Gallensteinlöffel  
Cucharillas para los cálculos biliares  
Curettes pour calculs biliaires  
Cucchiai per calcoli biliari



**MOORE**  
25-128-28  
28 cm, 11"

**Gall bladder scoop**  
Gallenblasenlöffel  
Cucharilla para la vesícula biliar  
Cuillère pour vésicule biliaire  
Cucchiaio per colecisti

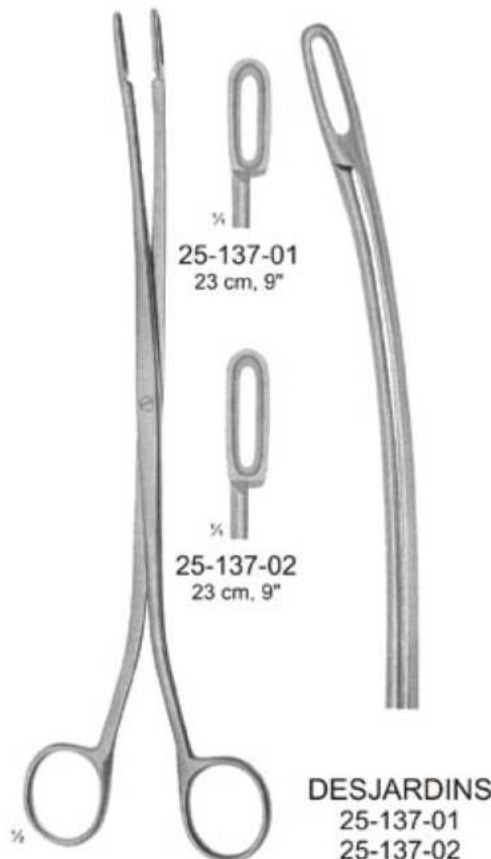
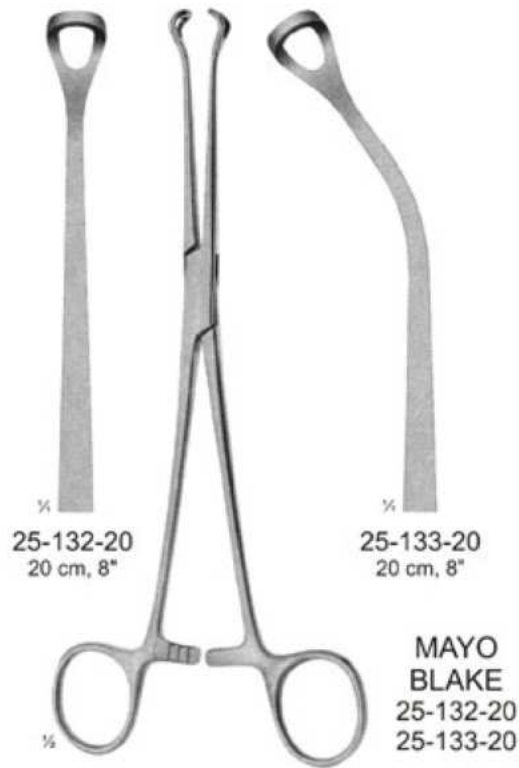
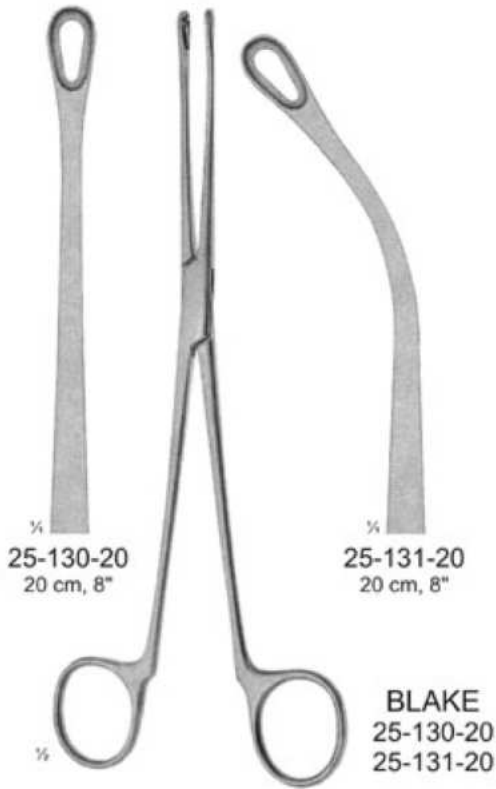

**Kidney elevating forceps**  
Nierenfaßzange  
Pinza para sostener el riñón  
Hystérolabe  
Pinza per afferrare il rene



25-155-01  
23 cm, 9"



25-155-02  
22 cm, 8 3/4"



25-155-03  
22 cm, 8 3/4"



25-155-04  
22 cm, 8 3/4"



**RANDALL**  
25-155-01  
25-155-04



25-157-01  
19 cm, 7 1/2"



25-157-02  
19 cm, 7 1/2"



**RANDALL**  
25-157-01  
25-157-02

**Kidney Stone Forceps**  
Nierensteinzangen  
Pinzas para los cálculos renales  
Pinces pour les calculs rénaux  
Pinze per calcoli renali



**ELSASSER**  
 25-170-20  
 20 cm, 8"



**ELSASSER**  
 25-172-20  
 20 cm, 8"

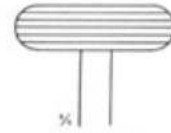

**25-184-01**  
 23 cm, 9"  
 Fig. 1



**25-184-02**  
 23 cm, 9"  
 Fig. 2

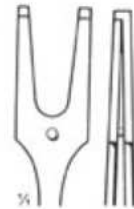

**25-184-03**  
 24 cm, 9½"  
 Fig. 3



**MILLIN**  
 25-180-23  
 23 cm, 9¼"



**MILLIN**  
 25-182-24  
 24,5 cm, 9½"



**MILLIN**  
 25-184-01  
 25-184-03



**YOUNG**  
 25-190-21  
 21,5 cm, 8½"

lateral  
 lateral  
 lateral  
 latéral  
 laterale



**YOUNG**  
 25-192-21  
 21 cm, 8½"

anterior  
 anterior  
 anterior  
 antérieur  
 anteriore



**YOUNG**  
 25-194-22  
 22 cm, 8¾"

**Bulbus hook**  
 Bulbus-Haken  
 Gancho para el bulbus  
 Crochet en bulbus  
 Bulbo ad uncino



**YOUNG**  
 25-196-21  
 21 cm, 8½"

**forked**  
 gegabelt  
 horquilla  
 en fourche  
 a forchetta



**LEGUEU**  
25-200-00

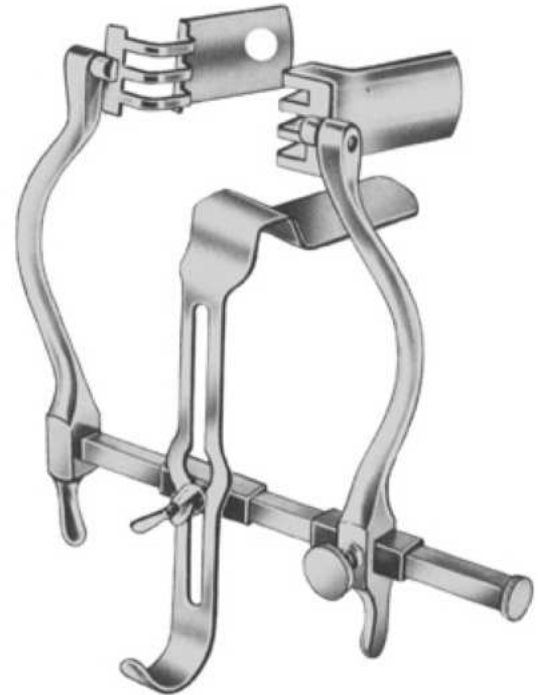

**JUDD-MASSON**  
25-202-00

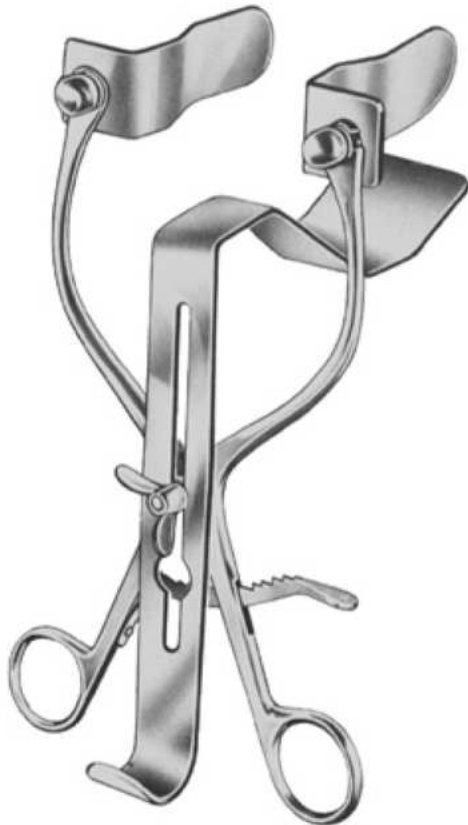

**MILLIN**  
25-204-00



**MILLIN**  
25-206-00

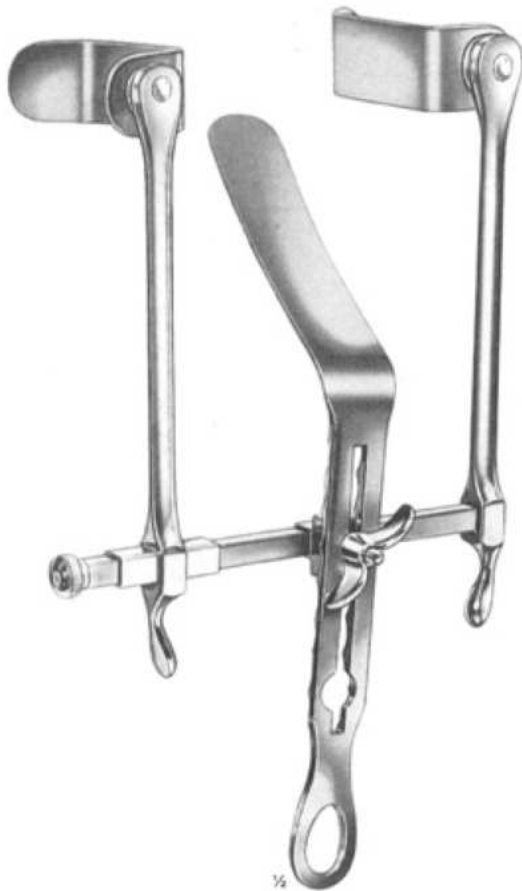

**TOMSON-WALKER**  
25-210-00

**LEGUEU**  
25-212-27  
27 cm, 10 1/2"



**MILLIN**  
25-214-29  
29,5 cm, 11 1/4"

**Bladder neck spreader**  
Blasenhalsspreizer  
Dilatador para el cuello vesical  
Dilatateur vésicale  
Dilatatore per collo vescicale

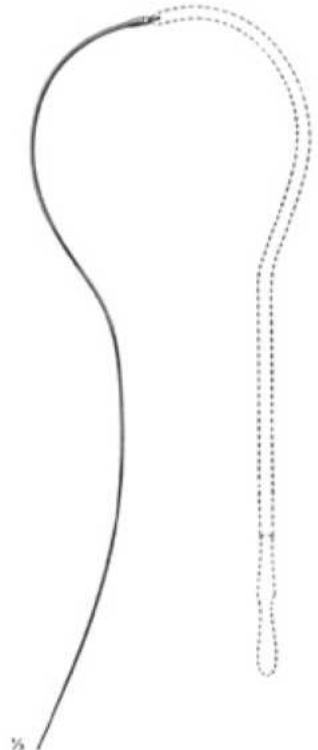

**VAN BUREN**

	ø mm	Chr. (French)
27,5 mm, 10 3/4"		
25-220-08	2 1/4	8
25-220-09	3	9
25-220-10	3 3/4	10
25-220-12	4	12
25-220-14	4 3/4	14
25-220-16	5 1/2	16
25-220-18	6	18
25-220-20	6 1/2	20
25-220-22	7 1/2	22
25-220-24	8	24
25-220-26	8 1/2	26
25-220-28	9 1/2	28
25-220-30	10	30
25-220-32	10 1/2	32
25-220-34	11 1/2	34
25-220-36	12	36

**Dilating bougies**  
Dilatationsbougies  
Bujías dilatadoras  
Bougies dilatatrices  
Candelette dilatatrici

	15 cm, 6"	ø mm	Chr. (French)	25 cm, 10"
25-224-08		2 1/2	8	25-225-08
25-224-10		3 1/2	10	25-225-10
25-224-12		4	12	25-225-12
25-224-14		4 1/2	14	25-225-14
25-224-16		5 1/2	16	25-225-16
25-224-18		6	18	25-225-18
25-224-20		6 1/2	20	25-225-20

**Metal Catheters for men**

Metallkatheter für männer

Sondas metálicas para hombres

Sondes vésicales métalliques pour hommes

Cateteri metallici per uomini

**Metal Catheters for women**

Metallkatheter für frauen

Sondas metálicas para mujeres

Sondes vésicales métalliques pour femmes

Cateteri metallici per donne

**25-228-26**  
26 1/2 cm, 10 1/2"

**Secretion curette malleable**

Sekretöffel, biegsam

Cucharilla para secreción, maleable

Cuillère pour prélèvements des sécrétions, malléables

Curetta per secrezioni, malleabile

**FILIFORM**  
25-230-12



**GUYON**  
25-234-00  
420 x 175 x 40mm



**GUYON**  
25-234-10  
25-234-30  
Chr, French  
No, 10-30



**GUYON**  
25-236-39  
39 cm, 15½"

**Catheter introducing instrument**

Katheter-Einführungsinstrument

Instrumento para introducir catéteres

Mandrin pour sondes en gomme

Strumento per introdurre cateteri o sonde



**GUYON**  
25-238-35  
35 cm, 13¾"

**Catheter guide (introducer)**

Katheterspanner und Einführungsinstrument

Gula para catéteres (introductor)

Mandrin pour sondes

Catetere guida (Introduttore)



**25-244-14**  
14,5 cm, 5¾"

**Fixation clamp for the spermatic cord**

Klemme zum fixieren des Samenstrangs

Piza para fijar el cordón espermático

Pince pour fixer le cordon

Pinza per fissare il tronco spermatico

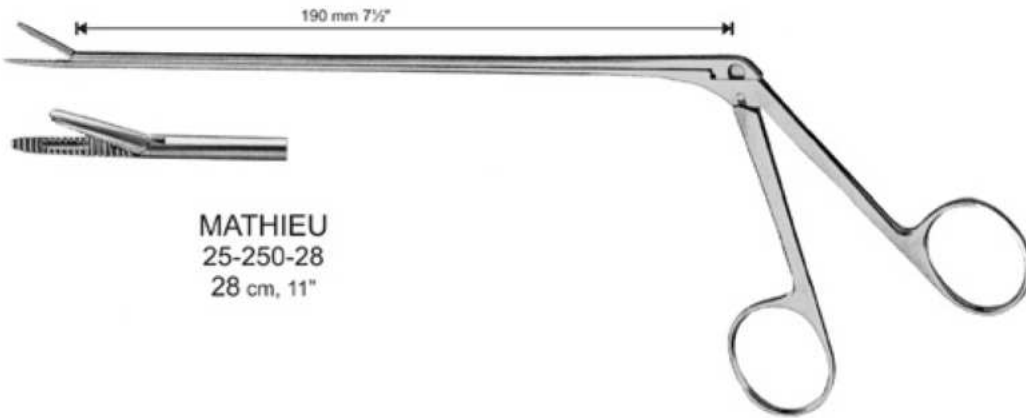

**MATHIEU**  
25-250-28  
28 cm, 11"



**Penis clamp**  
Penisklemme  
Compresor urétral  
Compresseur de l'urètre  
Serrapene

**STRAUSS**  
25-255-11  
11 cm, 4 3/4"



**Meatotome**  
Meatotom  
Meatólomo  
Métatome  
Meatotomy

**SACHSE**  
25-260-20  
20 cm, 8"

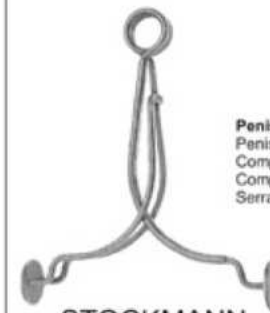

**Penis clamp**  
Penisklemme  
Compresor urétral  
Compresseur de l'urètre  
Serrapene

**STOCKMANN**  
25-265-08  
8 cm, 3 1/4"

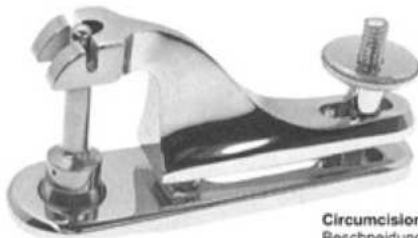

**Circumcision instruments**  
Beschneidungs- (Circumcisions-) Instrumente  
Instrumento para circuncisión  
Instrument de circoncision  
Strumento per circoncisione

25-270-08 ø8mm  
baby size, für Säuglinge, para bebés, pour bébés, per neonati

25-270-11 ø11mm

25-270-13 ø13mm

child size, für Knaben, para niños, pour garçons, per bambini

25-270-16 ø16mm

25-270-21 ø21mm

adolescent size, für jugendliche, para adolescentes, pour adolescents, per adolescent

25-270-26 ø26mm

25-270-32 ø32mm

men,s size, für Männer, para hombres, pour hommes, per uomini



**MOGEN**  
25-272-07  
7,5 cm, 3"

**Circumcision instrument**  
Beschneidungs- (Circumcisions-) Instrument  
Instrumento para circuncisión  
Instrument de circoncision  
Strumento per circoncisione