



Gynecology
Gynäkologie
Ginecología
Gynècologie
Ginecologia



Vaginal speculum for virgins with lateral fixation screw, tilt-down handle

Scheidenspekulum für Jungfrauen, mit zentraler Stellschraube, Griff umlegbar

Espécule vaginal para vírgenes, con tornillo de sujeto lateral, mango plegable

Spéculum vaginal pour vierges, avec fixation centrale à vis

Specolo vaginale per vergini, con vite di regolazione laterale



CUSCO
27-110-01
75 x 17 mm

Vaginal speculum for virgins with central fixation screw, tilt-down handle

Scheidenspekulum für Jungfrauen, mit zentraler Stellschraube, Griff umlegbar

Espécule vaginal para vírgenes, con tornillo de sujeto central, mango plegable

Spéculum vaginal pour vierges, avec fixation centrale à vis

specolo vaginale per vergini, con vite di regolazione centrale



CUSCO
27-112-01
75 x 17 mm

Scheme of dimensions for specula
Maßschema für Spekula
Esquema de dimensiones para espéculos
Schéma de dimensions pour les spéculums
Schema di dimensioni per specoli

Width of blades
Blattbreite
Anchura de valvas
Largeur de valves
Larghezza delle valve

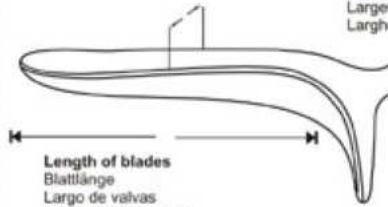

Length of blades
Blattlänge
Largo de valvas
Longueur des valves
Lunghezza delle valve

Vaginal specula with lateral fixation screw, tilt-down handle

Scheidenspekula mit seitlicher Stellschraube, Griff umlegbar

Espécules vaginales con tornillo de sujeto lateral, mango plegable

Spéculums vaginaux, avec fixation latérale à vis

Speculi vaginali, con vite di regolazione laterale



CUSCO
27-114-01 75 x 32 mm
27-114-02 85 x 35 mm
27-114-03 100 x 35 mm

Vaginal specula with central fixation screw, tilt-down handle

Scheidenspekula mit zentraler Stellschraube, Griff umlegbar

Espécules vaginales con tornillo de sujeto central, mango plegable

Spéculums vaginaux, avec fixation centrale à vis

Speculi vaginali, con vite di regolazione centrale



CUSCO
27-116-01 75 x 32 mm
27-116-02 85 x 35 mm
27-116-03 100 x 37 mm



Vaginal specula, Swiss pattern, cone shaped, with lateral fixation screw, tilt-down handle

Scheidenspekula, Schweizer Modell (konisch), mit seitlicher Stellschraube, Griff umlegbar

Espéculos vaginales, modelo suizo (cónico), con tornillo de sujeto lateral, mango plegable

Spéculum vaginaux, modèle suisse (conique), avec fixation latérale à vis

Speculi vaginali, modello svizzero, profilo a cono con vite di regolazione laterale

CUSCO

27-120-01 90 x 22
27-120-02 100 x 25
27-120-03 105 x 27

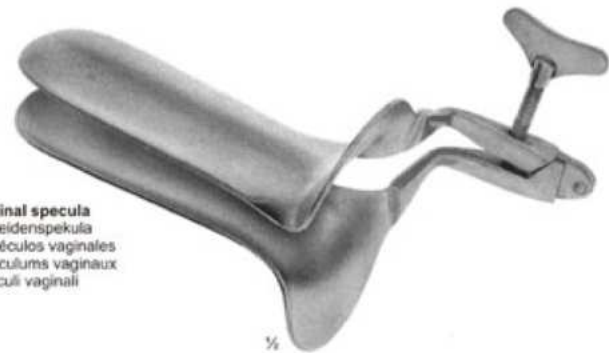

Vaginal specula
Scheidenspekula
Espéculos vaginales
Spéculum vaginaux
speculi vaginali

1/2

COLLIN

27-124-01 85 x 30mm
27-124-02 100 x 35 mm
27-124-03 110 x 40 mm

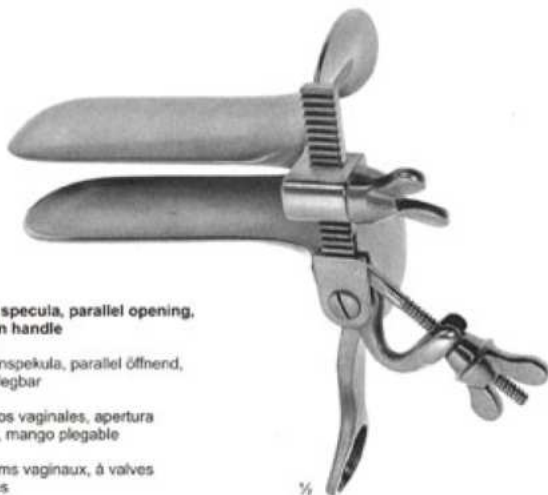

Vaginal specula, parallel opening, tilt-down handle

Scheidenspekula, parallel öffnend, Griff umlegbar

Espéculos vaginales, apertura paralela, mango plegable

Spéculum vaginaux, à valves parallèles

Speculi vaginali, apertura paralela

TRELAT

27-126-01 85 x 33 mm
27-126-02 95 x 35 mm
27-126-03 115 x 43 mm

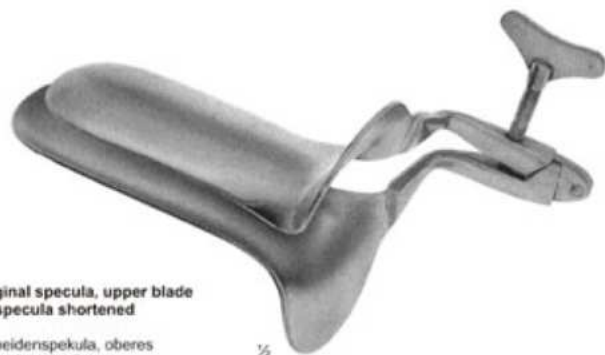

Vaginal specula, upper blade of specula shortened

Scheidenspekula, oberes spekulablatt kürzer

Espéculos vaginales, valvas superior más corta

Spéculum vaginaux, valve supérieure plus courte

Speculi vaginali, valva superiore corta

1/2

COLLIN-LANDAU

27-128-01 85 x 30 mm
27-128-02 100 x 35 mm
27-128-03 110 x 40 mm



Vaginal specula with double lock, one-hand operated

Scheidenspekula mit Doppelsperre, für einhandbedienung

Espéculos vaginales con cierre doble, para el uso con una mano

spéculum vaginaux, double ouverture utilisé à la main

Speculi vaginali, a doppio fermo, impiego con una mano

SEMM

- 27-136-01 90 x 14 x 18 mm
- 27-136-02 100 x 17 x 20 mm
- 27-136-03 100 x 25 x 30 mm



Vaginal specula
Scheidenspekula
Espéculos vaginales
Spéculum vaginaux
speculi vaginali

1/2

GRAVE

- 27-138-01 75 x 20 mm
- 27-138-02 95 x 35 mm
- 27-138-03 115 x 35 mm



Vaginal specula
Scheidenspekula
Espéculos vaginales
Spéculum vaginaux
speculi vaginali

PEDERSON

- 27-144-01 75 x 13 mm
- 27-144-02 100 x 16 mm
- 27-144-03 100 x 22 mm
- 27-144-04 120 x 25 mm



Vaginal speculum
Scheidenspekulum
Espéculo vaginal
Spéculum vaginal
speculo vaginale

1/2

DE VILBISS

- 27-148-01 102 x 32 mm



Surface black-finish
 Oberfläche geschwärzt
 Superficie negra
 Surface noire
 Superficie nera

PEDERSON

- 27-152-01 75 x 13 mm
- 27-152-02 100 x 22 mm
- 27-152-03 120 x 25 mm

Vaginal specula for laser surgery, suctioning from upper blade

Scheidenspekula für laserchirurgie, mit absaugung am oberen blatt

Espécules vaginales para la cirugía con laser, tubo de succión en la valva superior

Spéculum vaginaux pour chirurgie laser, avec embout aspiration sur la valve supérieure

Speculi vaginali per chirurgia laser, aspirazione dalla valva superiore

PEDERSON

- 27-154-01 75 x 13 mm
- 27-154-02 100 x 22 mm
- 27-154-03 120 x 25 mm

Vaginal specula for laser surgery, suctioning from lower blade

Scheidenspekula für laserchirurgie, mit absaugung am unteren blatt

Espécules vaginales para la cirugía con laser, tubo de succión en la valva inferior

Spéculum vaginaux pour chirurgie laser, avec embout aspiration sur la valve inférieure

Speculi vaginali per chirurgia laser, aspirazione dalla valva inferiore



Surface black-finish
 Oberfläche geschwärzt
 Superficie negra
 Surface noire
 Superficie nera

GRAVE

- 27-156-01 75 x 20 mm
- 27-156-02 95 x 35 mm
- 27-156-03 115 x 35 mm

Vaginal specula for laser surgery, suctioning from upper blade

Scheidenspekula für laserchirurgie, mit absaugung am oberen blatt

Espécules vaginales para la cirugía con laser, tubo de succión en la valva superior

Spéculum vaginaux pour chirurgie laser, avec embout aspiration sur la valve supérieure

Speculi vaginali per chirurgia laser, aspirazione dalla valva superiore

GRAVE

- 27-158-01 75 x 20 mm
- 27-158-02 95 x 35 mm
- 27-158-03 115 x 35 mm

Vaginal specula for laser surgery, suctioning from lower blade

Scheidenspekula für laserchirurgie, mit absaugung am unteren blatt

Espécules vaginales para la cirugía con laser, tubo de succión en la valva inferior

Spéculum vaginaux pour chirurgie laser, avec embout aspiration sur la valve inférieure

Speculi vaginali per chirurgia laser, aspirazione dalla valva inferiore



KOGAN
 27-166-24
 24 cm 9½"

Endospecula for cervix and urethra
 Endospekula für Hamröhre und cervix
 Endospecúlos para cerviz y uretra
 Speculum pour urètre et col utérin
 Endospeculi per cervice ed uretra



Lateral speculum
 Lateral-Spekulum
 Espécúlo lateral
 Speculum laterale
 Speculo laterale

27-168-25
 25 cm 10"



JACKSON
27-172-01
75 x 40 mm

27-172-02
90 x 40 mm

27-172-03
100 x 40 mm

1/2



SIMS
27-174-01
65 x 25 mm
70 x 30 mm
12,5 cm, 5"

27-174-02
70 x 30 mm
70 x 35 mm
15,0 cm, 6"

27-174-03
85 x 35 mm
90 x 40 mm
17,5 cm, 7"

1/2

Vaginal specula, double-ended
Scheidenspekula, doppelendig
Especulos vaginales, dobles
Spéculums vaginaux, doubles
Speculi vaginali, doppi

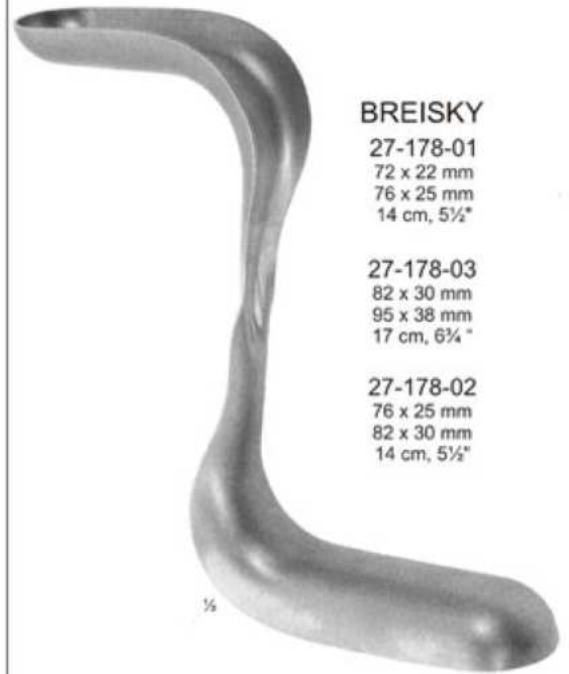

BREISKY
27-178-01
72 x 22 mm
76 x 25 mm
14 cm, 5 1/2"

27-178-03
82 x 30 mm
95 x 38 mm
17 cm, 6 1/4"

27-178-02
76 x 25 mm
82 x 30 mm
14 cm, 5 1/2"

1/2

Vaginal specula, double-ended
Scheidenspekula, doppelendig
Especulos vaginales, dobles
Spéculums vaginaux, doubles
Speculi vaginali, doppi



KRISTELLER

27-180-01
115 x 23 mm

27-180-02
115 x 26 mm

27-180-03
115 x 32 mm

1/2

Set of 1 speculum and 1 retractor each
Satz aus je 1 Spekulum und 1 Halter
Juego de 1 espéculo y 1 valva
Jeu de 1 spéculum et 1 valve
Set speculo e valva



KRISTELLER

27-182-01
70 x 27 mm

27-182-02
80 x 30 mm

27-182-03
90 x 36 mm

1/2

Specula only
Spekula allein
Especulos sueltos
Spéculums seuls
Solo speculi



KRISTELLER

27-184-01
75 x 23 mm

27-184-02
85 x 26 mm

27-184-03
100 x 32 mm

1/2

Retractors only
Halter allein
Valvas sueltas
Valves seules
Solo valve



Set of 1 speculum and 1 retractor each
Satz aus je 1 Spekulum und 1 halter
Juego de 1 espéculo y 1 valva
Jeu de 1 spéculum et 1 valve
Set speculo e valva

KRISTELLER
27-190-01
27-190-02

1/2



Specula only
Spekula allein
Espéculos sueltos
Spéculum seuls
Solo speculi

KRISTELLER
27-192-01
105 x 18 mm

27-192-02
105 x 21 mm

1/2



Retractors only
Halter allein
Valvas sueltas
Valves seules
Solo valve

KRISTELLER
27-194-01
110 x 14 mm

27-194-02
110 x 17 mm

1/2



Set of 1 speculum and 1 retractor each
Satz aus je 1 Spekulum und 1 halter
Juego de 1 espéculo y 1 valva
Jeu de 1 spéculum et 1 valve
Set speculo e valva

KRISTELLER
27-200-01
27-200-02
27-200-03

1/2



Specula only
Spekula allein
Espéculos sueltos
Spéculum seuls
Solo speculi

KRISTELLER
27-202-01
105 x 26 mm

27-202-02
105 x 28 mm

27-202-03
105 x 33 mm

1/2

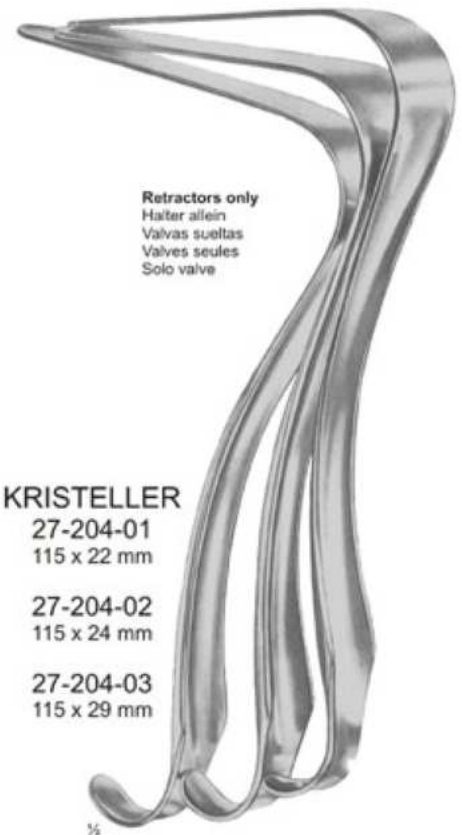

Retractors only
Halter allein
Valvas sueltas
Valves seules
Solo valve

KRISTELLER
27-204-01
115 x 22 mm

27-204-02
115 x 24 mm

27-204-03
115 x 29 mm

1/2



Set of 1 speculum and 1 retractor each
Satz aus je 1 Spekulum und 1 Halter
Juego de 1 espéculo y 1 valva
Jeu de 1 spéculum et 1 valve
Set speculo e valva

KRISTELLER
27-210-01
27-210-02
27-210-03



Specula only
Spekula allein
Especulos sueltos
Spéculum seuls
Solo speculi

KRISTELLER
27-212-01
110 x 27 mm
27-212-02
110 x 30 mm
27-212-03
110 x 36 mm



Retractors only
Halter allein
Valvas sueltas
Valves seules
Solo valve

KRISTELLER
27-214-01
115 x 23 mm
27-214-02
115 x 26 mm
27-214-03
115 x 32 mm

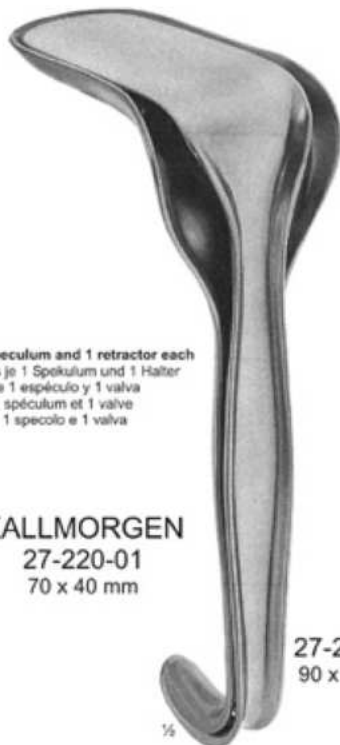

Set 1 speculum and 1 retractor each
Satz aus je 1 Spekulum und 1 Halter
Juego de 1 espéculo y 1 valva
Jeu de 1 spéculum et 1 valve
Serie da 1 speculo e 1 valva

KALLMORGEN
27-220-01
70 x 40 mm

27-221-02
90 x 40 mm



Specula only
Spekula allein
Especulos sueltos
Spéculum seuls
Solo speculi

MATHIEU
27-222-01
95 x 16-26 mm
27-222-02
95 x 16-30 mm



Retractors only
Halter allein
Valvas sueltas
Valves seules
Solo valve

MATHIEU
27-224-01
100 x 11-20 mm
27-224-02
100 x 14-26 mm



1/2

DOYEN

27-226-01 60 x 30 mm
27-226-02 70 x 30 mm
27-226-03 80 x 30 mm
25 cm, 10"

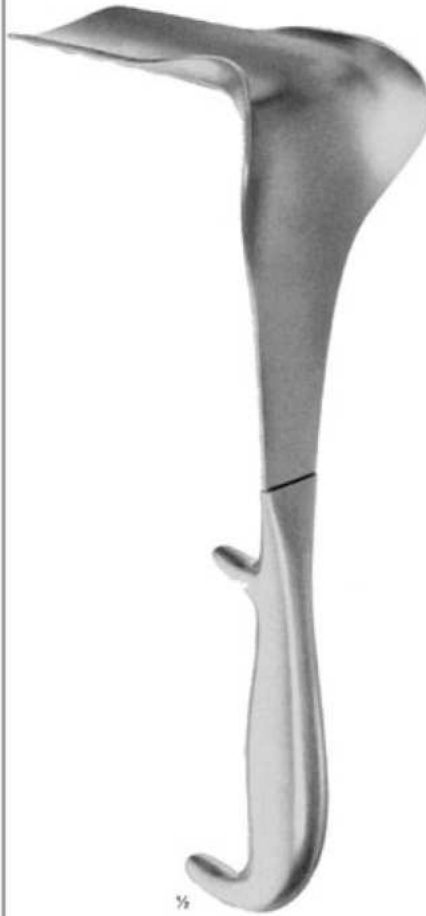

1/2

DOYEN

24 cm, 9 1/2"



1/2

DOYEN

24 cm, 9 1/2"

	Fig	A	B	
27-228-01	1	55mm	35mm	27-232-01
27-228-02	2	85mm	35mm	27-232-02
27-228-03	3	115mm	35mm	27-232-03
27-229-01	1	55mm	60mm	27-233-01
27-229-02	2	85mm	60mm	27-233-02
27-229-03	3	115mm	60mm	27-233-03
27-229-04	4	160mm	60mm	27-233-04
27-229-05	5	180mm	60mm	27-233-05
27-230-01	1	55mm	60mm	27-234-01
27-230-02	2	85mm	60mm	27-234-02
27-230-03	3	115mm	60mm	27-234-03
27-230-04	4	160mm	60mm	27-234-04
27-230-05	5	180mm	60mm	27-234-05



1/2

LANDAU

- 27-244-01 100 x 28 mm
- 27-244-02 105 x 38 mm



1/2

BREISKY

- 27-246-01 100 x 15 mm
- 27-246-02 100 x 20 mm
- 27-246-03 100 x 25 mm
- 27-246-04 100 x 30 mm
- 27-246-05 100 x 35 mm
- 27-246-06 100 x 40 mm
- 27-246-07 130 x 15 mm
- 27-246-08 130 x 20 mm
- 27-246-09 130 x 25 mm
- 27-246-10 130 x 30 mm
- 27-246-11 130 x 35 mm
- 27-246-12 130 x 40 mm
- 27-246-13 155 x 40 mm
- 27-246-14 180 x 40 mm



1/2

MATZENAUER

- 27-248-01 125 x 15 mm
- 27-248-02 125 x 20 mm
- 27-248-03 125 x 25 mm
- 27-248-04 125 x 30 mm
- 27-248-05 125 x 35 mm
- 27-248-06 125 x 40 mm



¼

AUVARD

27-252-01 70 x 38 mm

27-252-02 80 x 38 mm

27-252-03 102 x 38 mm

Vaginal specula with fixed weight
Scheidenspekula mit festem gewicht
Espéculos vaginal con peso fijo
Spéculums vaginal avec poids fixe
Speculi vaginali con peso fisso



¼

AUVARD-BERLIND

27-254-00 70 x 38 mm

27-254-01 80 x 38 mm

27-254-02 102 x 38 mm

Vaginal speculum with fixed weight and holes in blade
Scheidenspekulum mit festem Gewicht und löchern im blatt
Espéculo vaginal con peso fijo y valva perforada
Spéculum vaginal avec poids fixe et valve à trous
Speculo vaginale con peso fisso e fori sulla lama



¼

AUVARD

27-256-00 80 x 38 mm

27-256-01 102 x 45 mm

Vaginal speculum with detachable weight
Scheidenspekulum mit abnehmbarem gewicht
Espéculo vaginal con peso desmontable
Spéculum vaginal avec poids démontable
Speculo vaginale a peso smontabile



27-260-11
80 x 30 mm

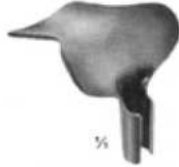

27-260-14
55 x 40-60mm



27-260-12
85 x 35 mm



27-260-15
70 x 45-70 mm



27-260-13
90 x 40 mm

Set, consisting of:
27-260-01 1 Handle
27-260-02 1 Weight 0,4 kg
27-260-11 1 Blade 80 x 30 mm
27-260-12 1 Blade 85 x 35 mm
27-260-13 1 Blade 90 x 40 mm
27-260-14 1 Blade 55 x 40-60 mm
27-260-15 1 Blade 70 x 45-70 mm

Juego, compuesto de:
27-260-01 1 Mango
27-260-02 1 Peso 0,4 kg
27-260-11 1 Valva 80 x 30 mm
27-260-12 1 Valva 85 x 35 mm
27-260-13 1 Valva 90 x 40 mm
27-260-14 1 Valva 55 x 40-60 mm
27-260-15 1 Valva 70 x 45-70 mm

Serie, composta da:
27-260-01 1 Manico
27-260-02 1 Peso 0,4 kg
27-260-11 1 Valva 80 x 30 mm
27-260-12 1 Valva 85 x 35 mm
27-260-13 1 Valva 90 x 40 mm
27-260-14 1 Valva 55 x 40-60 mm
27-260-15 1 Valva 70 x 45-70 mm

Satz, bestehend aus:
27-260-01 1 Griff
27-260-02 1 Gewicht 0,4 kg
27-260-11 1 Blatt 80 x 30 mm
27-260-12 1 Blatt 85 x 35 mm
27-260-13 1 Blatt 90 x 40 mm
27-260-14 1 Blatt 55 x 40-60 mm
27-260-15 1 Blatt 70 x 45-70 mm

Jeu, composé de:
27-260-01 1 Manche
27-260-02 1 Poids 0,4 kg
27-260-11 1 Valve 80 x 30 mm
27-260-12 1 Valve 85 x 35 mm
27-260-13 1 Valve 90 x 40 mm
27-260-14 1 Valve 55 x 40-60 mm
27-260-15 1 Valve 70 x 45-70 mm

27-260-02
0,4kg
27-260-03
0,8kg

SCHERBAK
27-260-00

Set, Satz, Juego, Jeu, Serie



80 x 42 mm

WEISSBARTH
27-264-00
80 x 42 mm

Vaginal speculum with removable strainer and perforated bottom

Scheidenspekulum mit abnehmbarem auffangsieb

Espéculo vaginal con tamiz desmontable

Spéculum vaginal avec tamis démontable

Speculo vaginaie con filtro smontabile et fondo forato



80 x 45 mm

17-950-02

110 x 70 mm

17-950-01

17-950-03

O'SULLIVAN-O'CONNOR
17-920-00

Set, Satz, Juego, Jeu, Serie

Abdominal retractor, complete, consisting of:
17-920-01 1 Frame with 2 lateral valves 62 x 25 mm
17-920-02 2 Valves 81 x 46 mm
17-920-03 1 Valve 110 x 72 mm

Bauchdeckenhalter, komplett, bestehend aus:
17-950-01 1 Rahmen mit 2 Seitenvalven 62 x 25 mm
17-950-02 2 Valven 81 x 46 mm
17-950-03 1 Valve 110 x 72 mm

Separador abdominal, completo, compuesto de:
17-950-01 1 Cuadro con 2 valvas laterales 62 x 25 mm
17-950-02 2 Valvas 81 x 46 mm
17-950-03 1 Valva 110 x 72 mm

Ecarteur abdominal, complet, composé de:
17-950-01 1 Cadre avec 2 valves latérales 62 x 25 mm
17-950-02 2 Valves 81 x 46 mm
17-950-03 1 Valve 110 x 72 mm

Divaricatore addominale, completo, composto da:
17-950-01 1 Telaio con valve laterali 62 x 25 mm
17-950-02 2 Valve 81 x 46 mm
17-950-03 1 Valva 110 x 72 mm



KOGAN
27-270-24
24 cm, 9½"

Endospeculum for cervix and urethra, without catch

Endospekulum für Harnröhre und Cervix, ohne Sperre

Endospéculo para uretra y cerviz, sin cierre

Endospéculum pour urètre et col utérin, sans verrou

Endospeculo per cervice e uretra, senza cremagliera



KOGAN
27-272-24
24 cm, 9½"

Endospeculum for cervix and urethra, with scale-ratchet and fixing screws

Endospekulum für Harnröhre und Cervix, mit Skaliensperre und Fixierschraube

Endospéculo para uretra y cerviz, con cierre graduado y tornillo fijador

Endospéculum pour urètre et col utérin crémailière à vis

Endospeculo per cervice e uretra, con nottolino graduato a vite di fissaggio



KOGAN
27-274-24
24 cm, 9½"

Endospeculum for cervix and urethra, with catch

Endospekula für Harnröhre und Cervix, mit Sperre

Endospéculos para uretra y cerviz, con cierre

Endospéculums pour urètre et col utérin, avec crémailière avec verrou

Endospecul per cervice e uretra, con cremagliera



GOODELL
27-276-34
34 cm, 13½"

Uterine dilator
Uterus-Dilatator
Dilatador uterino
Dilatateur du col de l'utérus
Dilatatore uterino



SIMS
27-280-32
32 cm, 12½"

Graduated in inch, malleable, silver-plated

mit Zolleinteilung, biegsam versilbert

Graduado en pulgadas, maleable, plateado

Gradué en pouces, malléable, argent

Graduato in pollici, malleabile, placcato in argento



SIMS
27-282-32
32 cm, 12½"

Graduated in centimeters, malleable, silver-plated

mit Zelleinteilung, biegsam versilbert

Graduado en centímetros, maleable, plateado

Gradué en cm, malléable, argent

Graduato in cm, malleabile, placcato in argento



SIMS
27-286-32
32 cm, 12½"

Graduated in centimeters, malleable, 18/8 steel

mit Zelleinteilung, biegsam 18/8 Stahl

Graduado en centímetros, maleable, acero 18/18

Gradué en cm, malléable, acier inox

Graduato in cm, malleabile, acciaio inox 18/8



SIMPSON
27-288-34
34 cm, 13½"

Graduated in centimeters, malleable, silver-plated

Mit Zentimeterinteilung, biegsam, versilbert

Graduado en centímetros, maleable, plateado

gradué en cm, malleable, argent

Graduto in cm, malleabile, placcato in argento



VALLEIX
27-294-25
25 cm, 10"

Graduated in centimeters, with slider, malleable, Chromium plated

mit Zelleinteilung, und schieber, biegsam, verchromt

Graduado en centímetros, con un cursor, maleable, cromado

Gradué en cm avec curseur, malléable, chromé

Graduato in cm, con cursore, malleabile, cromato



BRAUN
27-300-28
28 cm, 11"

Uterine depressor
Uterus-Depressor
Depresor uterino
Dépresseur utérin
Depressori uterini

Uterine gauze packer
Tamponadeführer
Conductor de tampones
Conducteur porte-tampon
Porta garzaa uterino



SIMS
27-304-26
26 cm, 10 1/4"

Uterine depressor
Uterus-Depressor
Depresor uterino
Dépresseur utérin
Depressori uterini

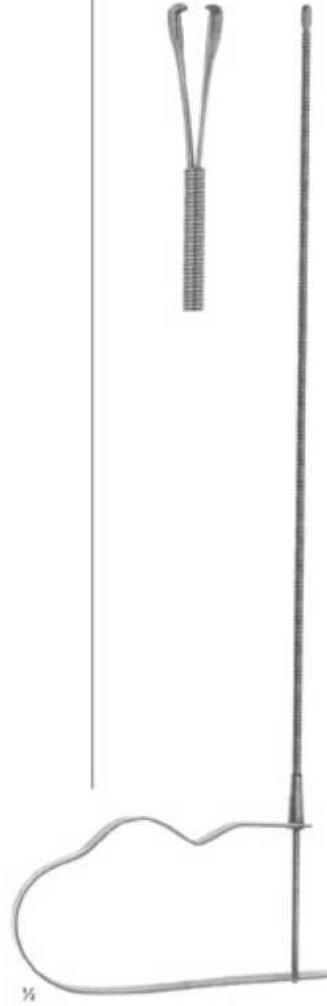

27-306-01 3 mm x 220 mm
27-306-02 3 mm x 285 mm

IUD (Intra Uterine Device)- Forceps with flexible shaft
IUP (Intrauterinpressar)- Faßzangen mit flexiblem Schaft
Pinzas DIU (Dispositivo Intra-Uterino) con vástago flexible
Pinze-DIU tige flexible
Pinza intra-uterina con asta flessibile



AMANN
27-310-32
32 cm, 12 1/2"

Uterine gauze packer
Tamponadeführer
Conductor de tapones
Conducteur porte-tampon
Porta garza uterino



1/2

HEGAR

- 27-322-01 Ø 1,0 mm
 - 27-322-02 Ø 2,0 mm
 - 27-322-03 Ø 3,0 mm
 - 27-322-04 Ø 4,0 mm
 - 27-322-05 Ø 5,0 mm
 - 27-322-06 Ø 6,0 mm
 - 27-322-07 Ø 7,0 mm
 - 27-322-08 Ø 8,0 mm
 - 27-322-09 Ø 9,0 mm
 - 27-322-10 Ø 10,0 mm
 - 27-322-11 Ø 11,0 mm
 - 27-322-12 Ø 12,0 mm
 - 27-322-13 Ø 13,0 mm
 - 27-322-14 Ø 14,0 mm
 - 27-322-15 Ø 15,0 mm
 - 27-322-16 Ø 16,0 mm
 - 27-322-17 Ø 17,0 mm
 - 27-322-18 Ø 18,0 mm
 - 27-322-19 Ø 19,0 mm
 - 27-322-20 Ø 20,0 mm
 - 27-322-21 Ø 21,0 mm
 - 27-322-22 Ø 22,0 mm
 - 27-322-23 Ø 23,0 mm
 - 27-322-24 Ø 24,0 mm
 - 27-322-25 Ø 25,0 mm
 - 27-322-26 Ø 26,0 mm
- 18,5 cm, 7 1/4"

With sloped handle
Mit glattem Muldengriff
con mango aplanado
à manche aplati
con manico iclinato



1/2

HEGAR

- 27-323-01 Ø 1,5 mm
 - 27-323-02 Ø 2,5 mm
 - 27-323-03 Ø 3,5 mm
 - 27-323-04 Ø 4,5 mm
 - 27-323-05 Ø 5,5 mm
 - 27-323-06 Ø 6,5 mm
 - 27-323-07 Ø 7,5 mm
 - 27-323-08 Ø 8,5 mm
 - 27-323-09 Ø 9,5 mm
 - 27-323-10 Ø 10,5 mm
 - 27-323-11 Ø 11,5 mm
 - 27-323-12 Ø 12,5 mm
 - 27-323-13 Ø 13,5 mm
 - 27-323-14 Ø 14,5 mm
 - 27-323-15 Ø 15,5 mm
 - 27-323-16 Ø 16,5 mm
 - 27-323-17 Ø 17,5 mm
- 18,5 cm, 7 1/4"

With sloped handle
Mit glattem Muldengriff
con mango aplanado
à manche aplati
con manico iclinato



HEGAR
27-330-00



HEGAR
27-330-01

Set in metal case
Satz in Metallkoffer
Juego en estuche de metal
jeu en boîte métallique
Serie in scatola metallica

Pieces per set	set	set
Stück per Satz	Satz	27-330-00
Piezas por juego	juego	
Pièces per jeu	jeu	
Pezzi per serie	serie	
14	4,0-17,0 mm	27-330-00
26	1,0-26,0 mm	27-330-01



1/2

23-336-02

HEGAR

- 27-336-02 Ø 1/2 mm
- 27-336-03 Ø 2/3 mm
- 27-336-04 Ø 3/4 mm
- 27-336-06 Ø 5/6 mm
- 27-336-08 Ø 7/8 mm
- 27-336-10 Ø 9/10 mm
- 27-336-12 Ø 11/12 mm
- 27-336-14 Ø 13/14 mm
- 27-336-16 Ø 15/16 mm
- 27-336-18 Ø 17/18 mm
- 27-336-20 Ø 19/20 mm
- 27-336-22 Ø 21/22 mm
- 27-336-24 Ø 23/24 mm
- 27-336-26 Ø 25/26 mm

20 cm, 8"



HEGAR
27-338-00

Dilator set, consisting of:
27-336-04, 27-336-18 8 Dilators Ø 3/4-17/18 mm
27-338-01 1 Boilable canvas roll

Dilatatoren-Satz, bestehend aus:
27-336-04, 27-336-18 8 Dilatoren Ø 3/4-17/18 mm
27-338-01 1 auskochbare Segeltuchrolle

Juego de dilatadores, compuesto de:
27-336-04, 27-336-18 8 Dilatadores de Ø 3/4-17/18 mm
27-338-01 1 Bolsa de tela esterilizable por ebullición

Jeu de dilateurs, composé de:
27-336-04, 27-336-18 8 Dilateurs de Ø 3/4-17/18 mm
27-338-01 1 Trousse stérilisable par ébullition

Set dilatatori, composto da:
27-336-04, 27-336-18 8 Dilatatori Ø 3/4-17/18 mm
27-338-01 1 Borsa telata sterilizzabile

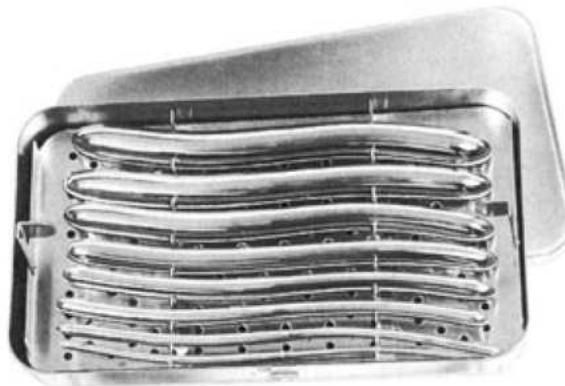

27-340-00



27-340-01

Set in metal case
Satz in Metalltui
Juego en estuche de metal
Jeu en boîte métallique
Serie in scatola metallica

Pieces per set	set	
Stück per Satz	Satz	
Piezas por juego	juego	
Pièces par jeu	jeu	
Pezzi per serie	serie	

14	4,0-17,0 mm	27-340-00
26	1,0-26,0 mm	27-340-01



¼

HANK

- 27-340-05 Ø 4,5/ 5,0 mm
- 27-340-06 Ø 5,5/ 6,0 mm
- 27-340-07 Ø 6,5/ 7,0 mm
- 27-340-08 Ø 7,5/ 8,0 mm
- 27-340-09 Ø 8,5/ 9,0 mm
- 27-340-10 Ø 9,5/ 10,0 mm

Set , Satz , Juego , Jeu , Serie



¼

27-442-00

Set , Satz , Juego , Jeu , Serie

Uterine Tenaculum Forceps

Hakenzangen

Pinzas para coger el cuello del útero

Pinces pour abaissement du col de l'utérus

Pinze per abbassare il collo dell'utero



027



BERNHARD
27-350-16
16 cm, 6¼"



STAUDE-MOORE
27-352-17
17 cm, 6¾"



ADAIR
27-354-18
18 cm, 7"

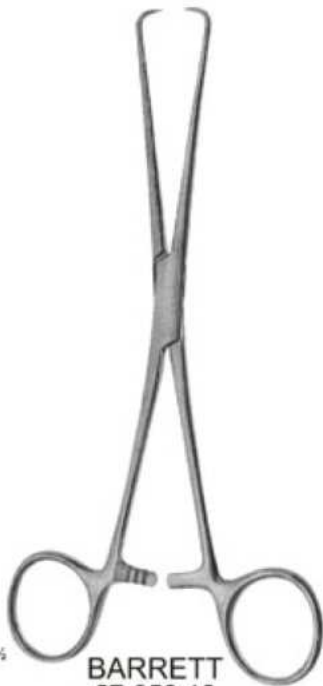

BARRETT
27-356-18
18 cm, 7"



SCHROEDER
27-358-25
25 cm, 10"

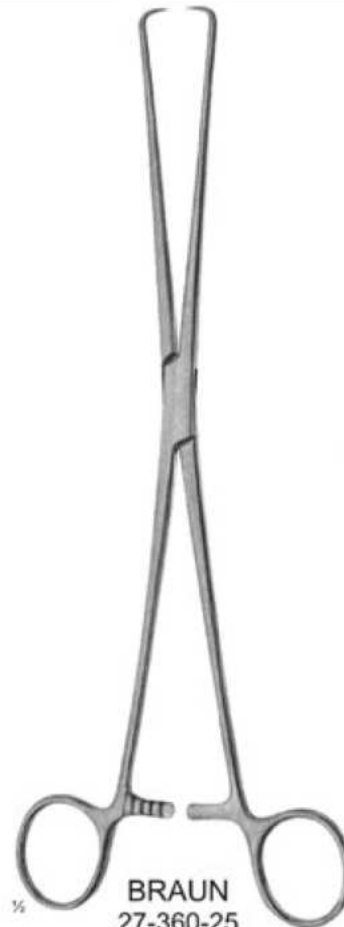

BRAUN
27-360-25
25 cm, 10"



BEACHAM
29-366-26
26 cm, 10¼"

Amniotome for the amnion bladder

Amniotom für die Amnionblase

Amniotomo para la vejiga amniótica

Amniotome pour le liquide amniotique

Amniotomo per la vescica amniotica



POZZI
27-370-25
25,5 cm, 10"

Heavy Pattern
Kräftiges Modell
Modelo fuerte
Modèle fort
Modello pesante



DUPLAY
27-373-28
28 cm, 11"



SCHRODER
27-374-25
25,5 cm, 10"



SKENE
27-379-24
24 cm, 9½"

Uterine Tenaculum Forceps

Hakenzangen

Pinzas para coger el cuello del útero

Pinces pour abaissement du col de l'utérus

Pinze per abbassare il collo dell'utero



027



LAHEY
27-380-15
15 cm, 6"
27-380-20
20 cm, 8"



BRAUN
27-382-15
15,5 cm, 6¼"



CZERNY
27-386-20
20,5 cm, 8¼"

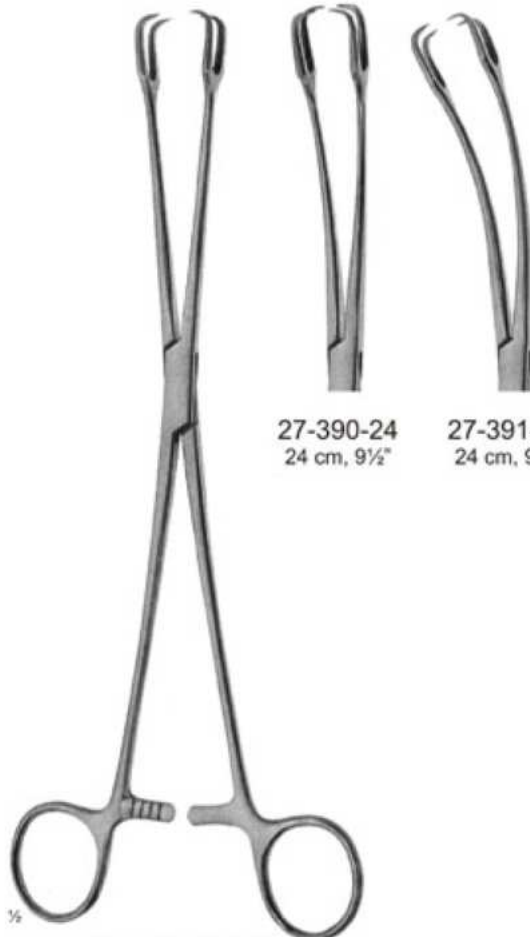

27-390-24
24 cm, 9½"

27-391-24
24 cm, 9½"

SCHROEDER
27-390-24
27-391-24



PRATT
27-398-26
26 cm, 10¼"

Uterine Tenaculum Forceps

Hakenzangen

Pinzas para coger el cuello del útero

Pinces pour abaissement du col de l'utérus

Pinze per abbassare il collo dell'utero

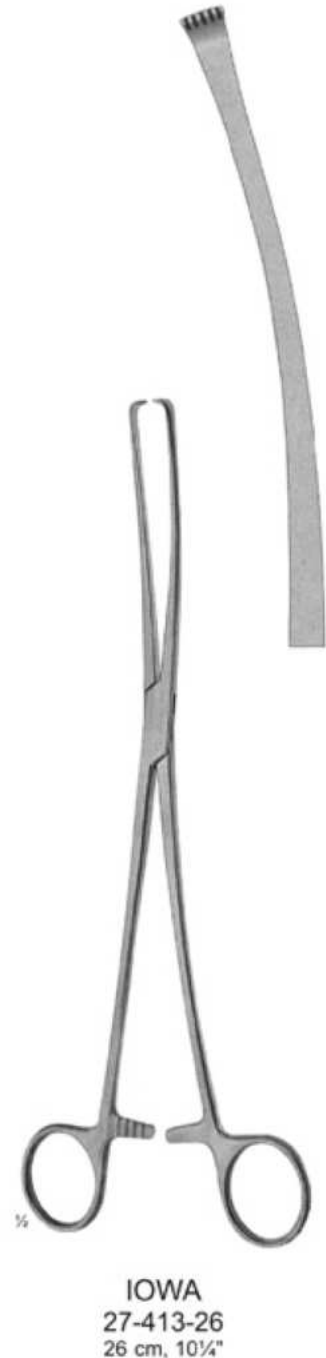
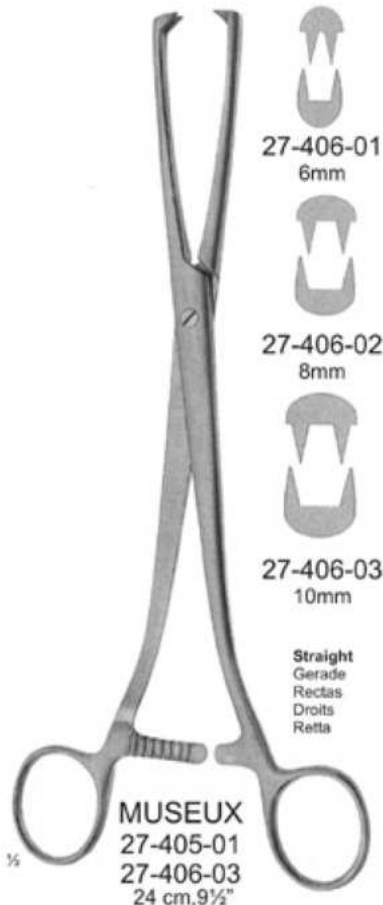
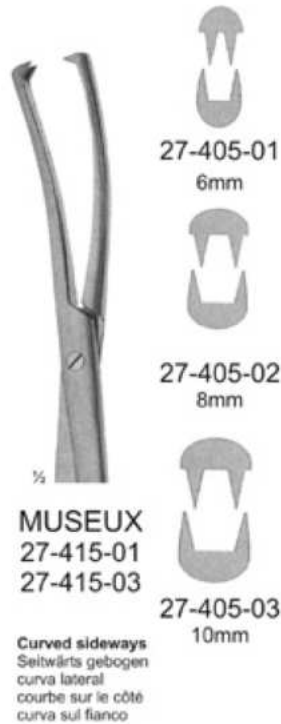

Membrane puncturing forceps, 5x6 teeth
Blasensprenger, 5x6 Zähne
Pinza para la vejiga amniótica 5x6 dientes
Pince perce membrane, 5x6 dents
Pinza per puntura amniotica, 5x6 denti





NOTO
27-430-20
20 cm, 8"



HEYWOOD-SMITH
27-432-27
27 cm, 10½"



KELLY
27-436-32
32 cm, 12½"



DARTIGVES
 27-450-27
 27 cm, 10½"



COLLIN
 27-454-25
 25 cm, 10"



SOMER
 27-458-23
 23 cm, 9"

Spone and Dressing Forceps

Kourn-und Tupferzangen

Pinzas para vendajes y torundas

Pinces à pansements et tampons

Pinze per medicatura e tamponi

Biopsy Curettes

Biopsieküretten

Curetas pour biopsia

Curettes pour biopsie

Curette per biopsia



COLLIN
27-484-25
25 cm, 10"



COLLIN
27-488-28
28,5 cm, 11¼"

Endometrial suction biopsy curette

Endometrium-Saugbiopsiekürette

Cureta aspiradora par biopsia endo-uterina

Curette aspiratrice pour biopsie de l'endomètre

Curette aspirante per la biopsia dell'endometrio



RANDALL
27-490-24
24 cm, 9½"

Endometrial suction biopsy curette

Endometrial-Saugbiopsiekürette

Cureta aspiradora par biopsia endo-uterina

Curette aspiratrice pour biopsie de l'endomètre

Curette aspirante per la biopsia dell'endometrio



NOVAK
27-492-23
23 cm, 9"



DOYEN
27-494-14
14 cm, 5½"

Myoma screw Ø 20 mm
Mayomheber Ø 20 mm
Tirabuzón para mioma Ø 20 mm
Tracteur pour fibrome Ø 20 mm
Succhiello per fibroma Ø 20 mm

DOYEN
27-494-17
17 cm, 6¾"

Myoma screw Ø 29 mm
Mayomheber Ø 29 mm
Tirabuzón para mioma Ø 29 mm
Tracteur pour fibrome Ø 29 mm
Succhiello per fibroma Ø 29 mm



SIMON
27-495-22
22 cm, 8¾"

SIMON
27-496-22
22 cm, 8¾"



SEGOND
27-497-27
27 cm, 10¾"



AYRE
27-499-23
23 cm, 9"



MOD-MUNCHEN
27-500-27
27 cm, 10½"

Endometrial biopsy curette
Endometriumstrichkürette
Cureta para biopsia endo-uterina
Curette à biopsie de l'endometre
Curetta per la biopsia dell'endometrio



KEVOURKIAN YOUNGE
27-502-01
30 cm, 12"

Endocervical biopsy curette
Endocervixbiopsiekürette
Cureta para biopsia endo-cerviz
Curette à biopsie endocervicale
Curetta per la biopsia endo-cervicale

KEVOURKIAN YOUNGE
27-502-02
30 cm, 12"



MILLIN
27-510-01
27-512-03

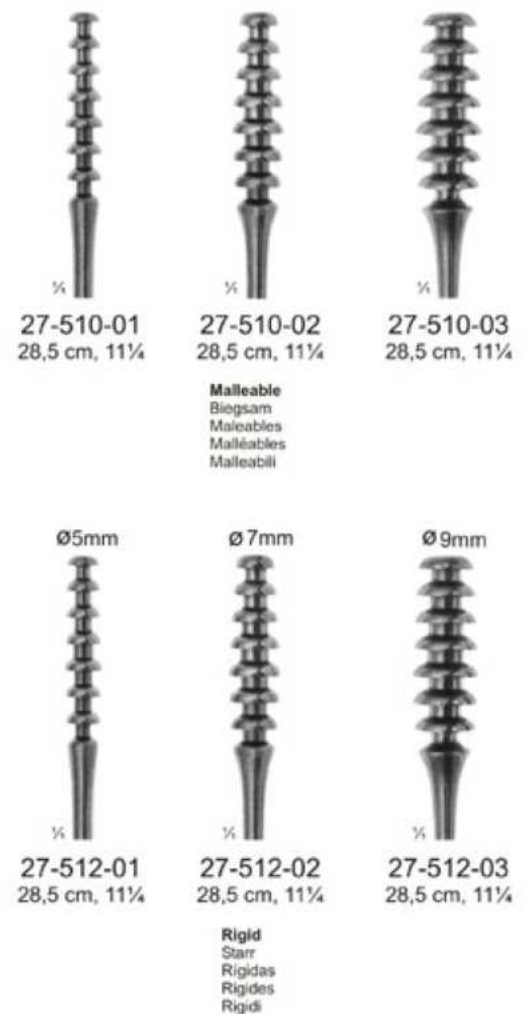

27-510-01
28,5 cm, 11¼"

27-510-02
28,5 cm, 11¼"

27-510-03
28,5 cm, 11¼"

Malleable
Biogsam
Maleables
Malleables
Malleabili

Ø5mm
27-512-01
28,5 cm, 11¼"

Ø7mm
27-512-02
28,5 cm, 11¼"

Ø9mm
27-512-03
28,5 cm, 11¼"

Rigid
Starr
Rigidas
Rigides
Rigidi

Endocervical biopsy curettes, working portion consisting of several concave-shaped circular knives, arranged one beneath the other

Endocervix-Biopsieküretten, Arbeitsteil bestehend aus mehreren, untereinander angeordneten konkaven Rundmessern

Cureta para biopsia endo-cerviz, con cuchillos redondos colocados uno sobre otro, concavos

Curettes pour biopsie endo-cervicale constituées de plusieurs parties tranchantes circulaires concaves

Curette per la biopsia endo-cervicale, con parte attiva formata da dischi, taglianti concavi sistemati l'uno sull'altro



27-525-21
21 cm, 8¼"



GELLHORN
27-521-23
23 cm, 9"



FAURE
27-525-21
21 cm, 8¼"



SCHUBERT
27-528-21
27-528-29



1/2



1/2



1/2



1/2



1/2

THOMAS-GAYLOR
 27-531-24
 24 cm, 9 1/2"

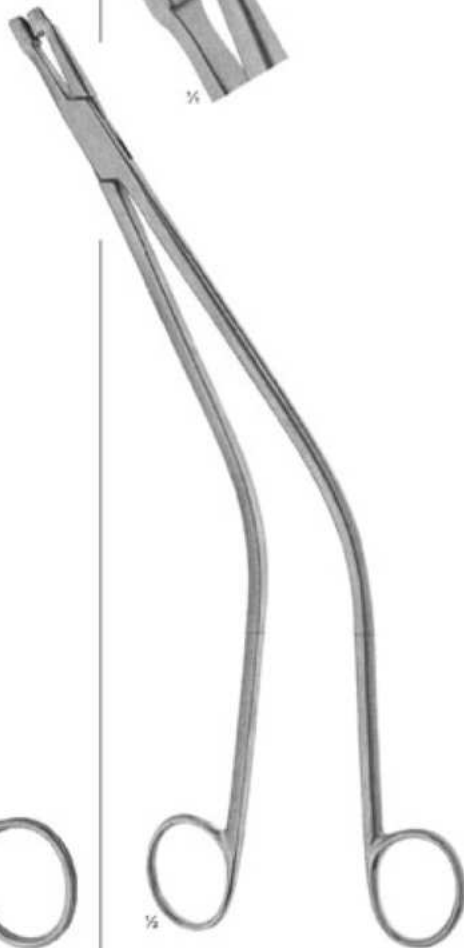

1/2

SCHUBERT
 27-535-26
 26 cm, 10 1/4"



1/2

VAN-DOREN
 27-537-24
 24 cm, 9 1/2"



1/2

VAN-DOREN
 27-539-25
 25 cm, 10"

Cervical biopsy and specimen forceps
 Uterus-Biopsiezange
 Pinza saca-bocados para biopsia
 Pince emporte-pièces à biopsie
 Pinza per la biopsia cervicale e da prelievo



TISCHLER
 27-543-27
 27 cm, 10 1/4"



SCHUMACHER-VAN DOREN
 27-547-01
 27-547-02



SEIDL DBP
 27-551-01
 27-551-03

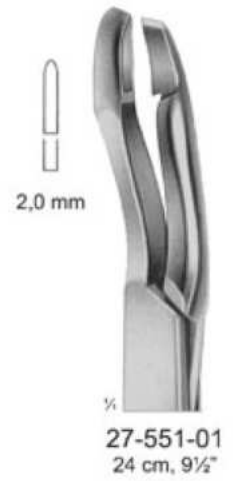

27-551-01
 24 cm, 9 1/2"

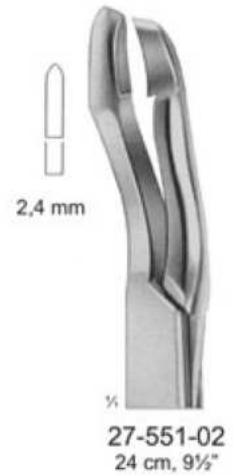

27-551-02
 24 cm, 9 1/2"



27-551-03
 24 cm, 9 1/2"

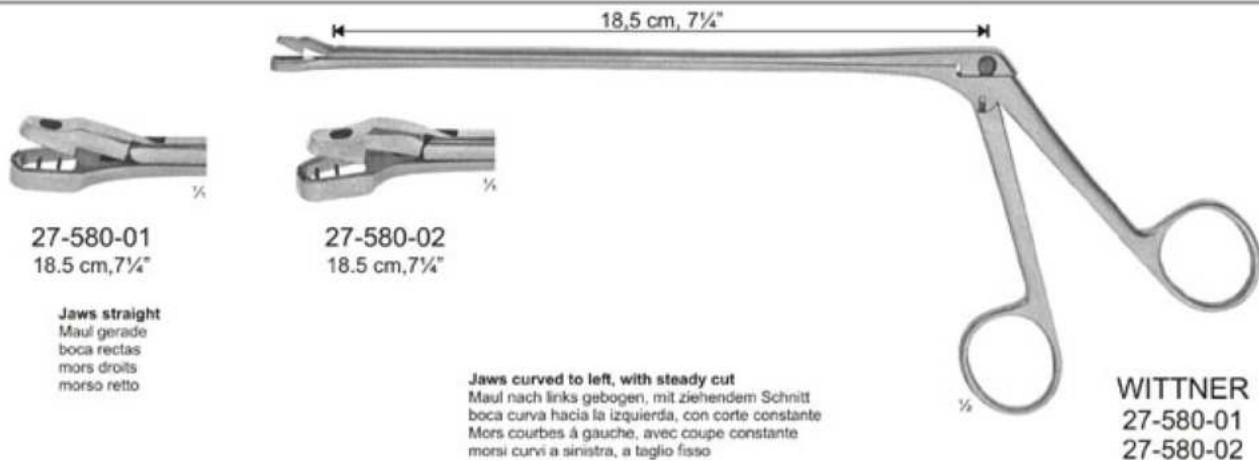
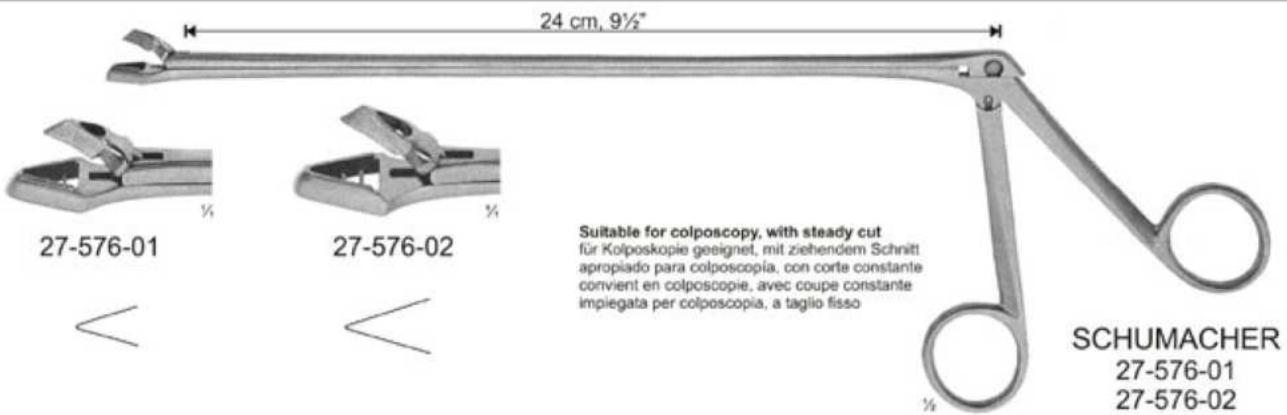
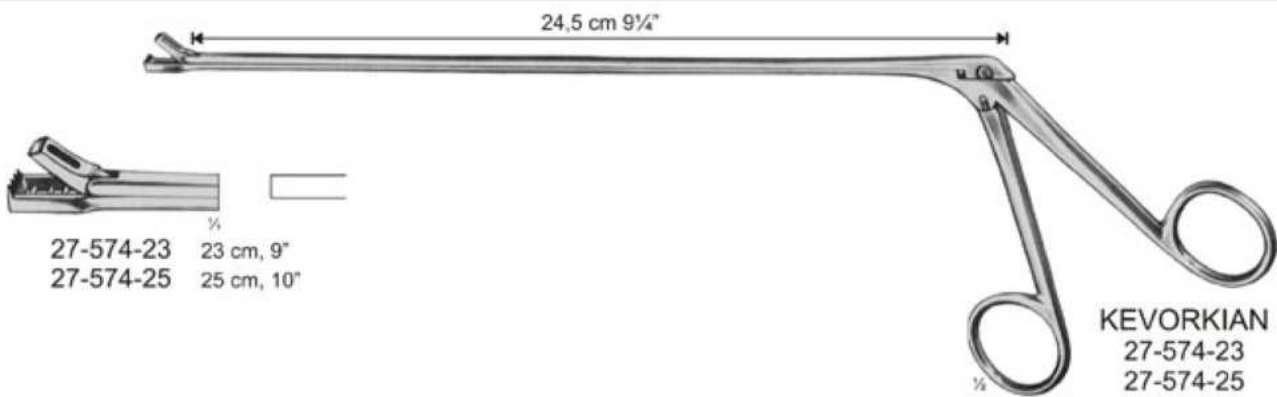
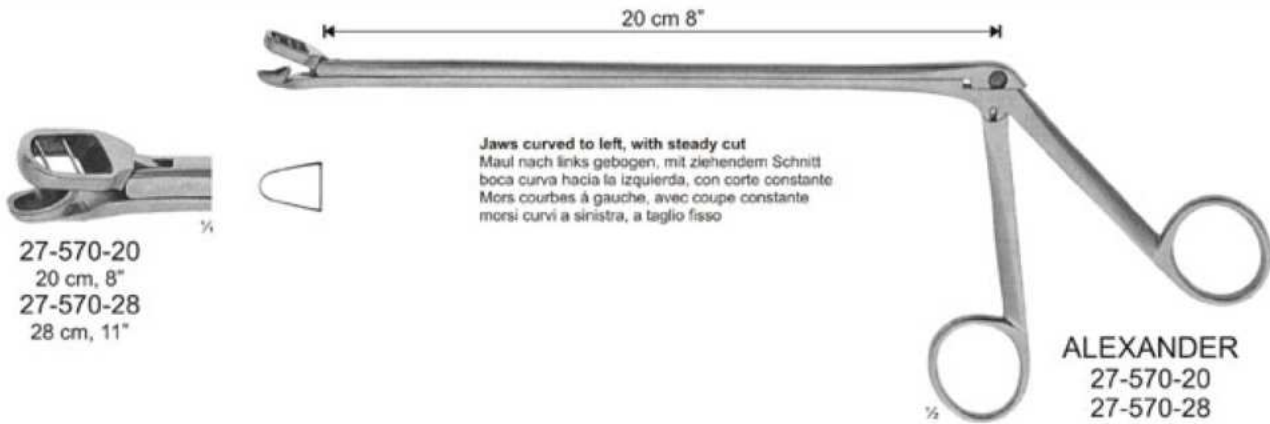

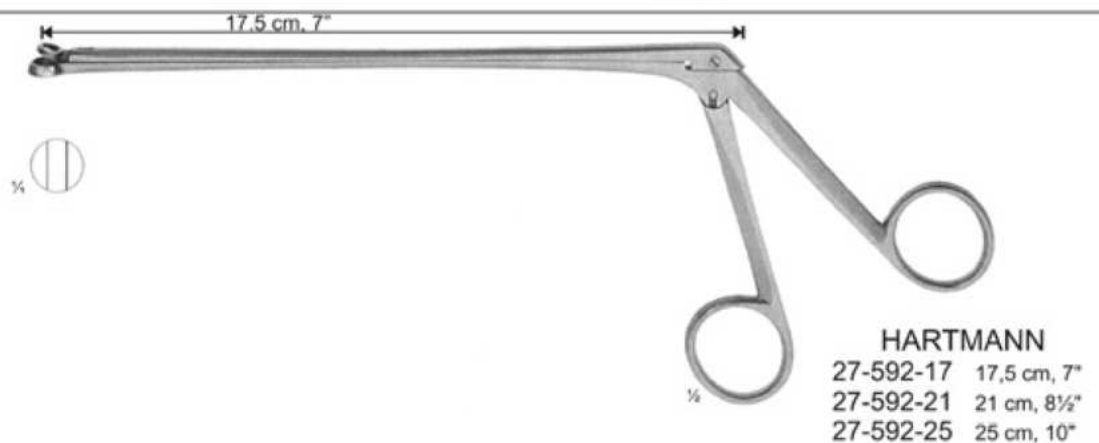
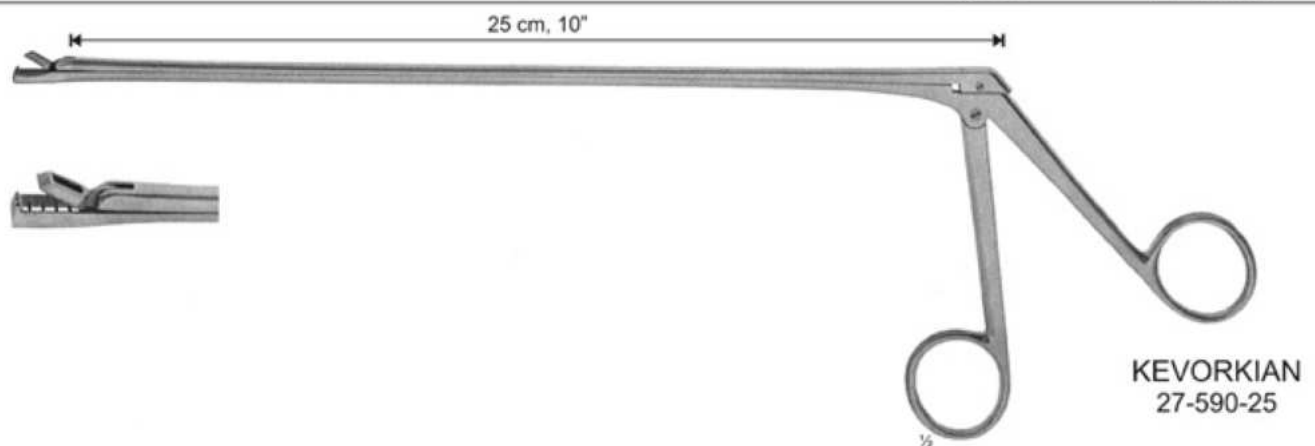
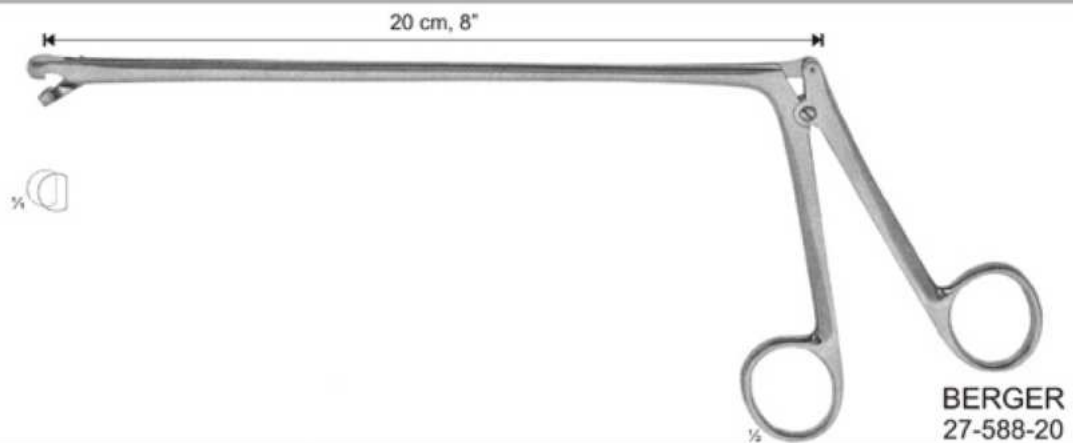
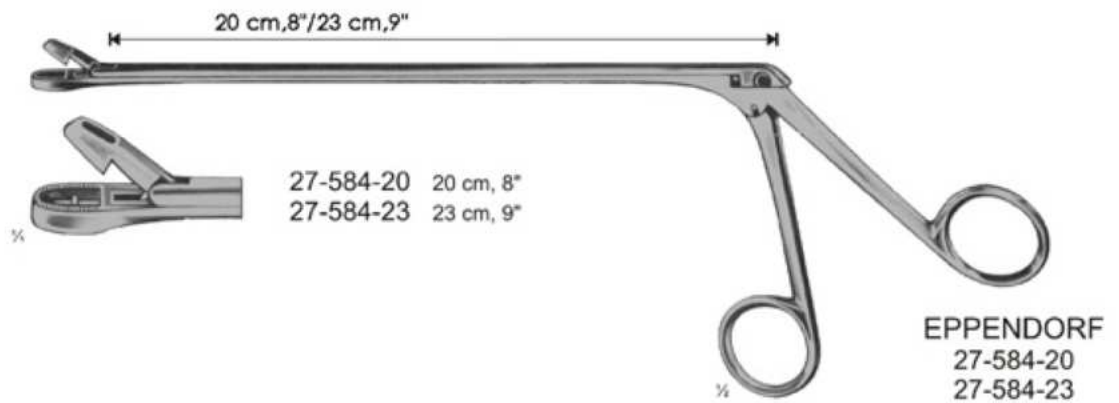

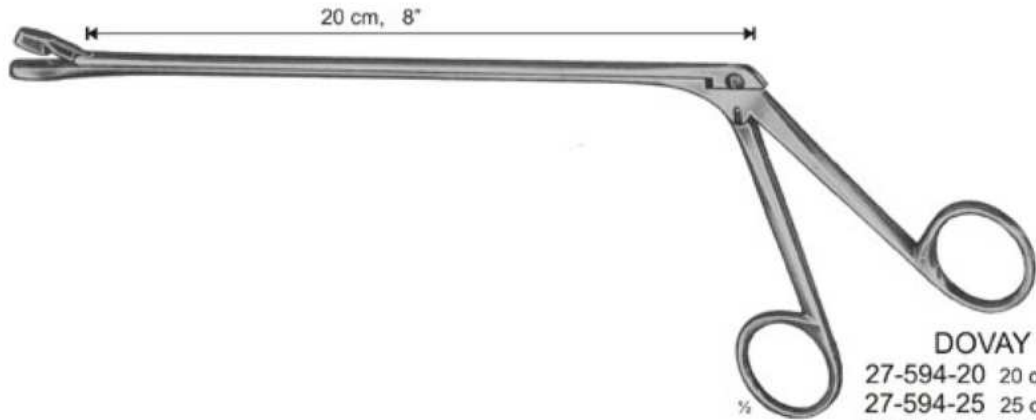

DOVAY

- 27-594-20 20 cm, 8"
- 27-594-25 25 cm, 10"
- 27-594-30 30 cm, 12"
- 27-594-35 35 cm, 14"
- 27-594-40 40 cm, 16"

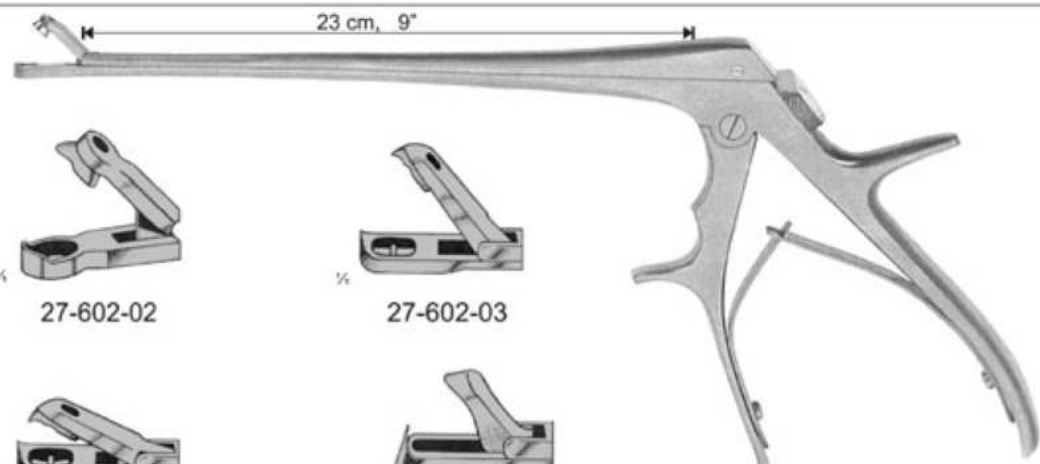

BURKE

- 27-602-01
- 27-602-05
- 23 cm, 9"



27-602-01



27-602-02



27-602-03



27-602-04



27-602-05

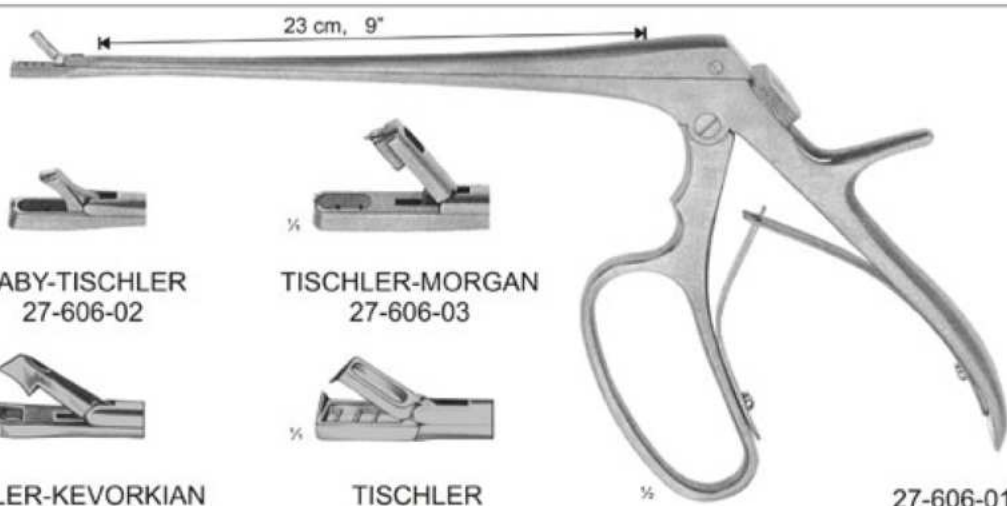

- 27-606-01
- 27-606-05
- 23 cm, 9"



KEVOURKIAN-PACEIFIC
27-606-01



BABY-TISCHLER
27-606-02



TISCHLER-MORGAN
27-606-03



TISCHLER-KEVORKIAN
27-606-04



TISCHLER
27-606-05



Cervical Biopsy and Specimen Forceps

Uterus-Biopsiezangen

Pinzas saca-bocados para biopsia

Pinces emporte-pièces à biopsie

Pinze per la biopsia cervicale e da prelievo



Complete instrument
Instrument komplett
Instrumento completo
Instrument complet
Strumento completo













Complete instrument
Instrument komplett
Instrumento completo
Instrument complet
Strumento completo



Tip with tube
Aufsatz mit Rohr
Punta con tubo
Tige avec embout
Punta con asta

Handle
Griff
Manigo
Manche
Manico

<p>Straight Gerade Recta Droit Retta</p>	 <p>TOWNSEND 27-610-01</p>	 <p>TISCHLER 27-610-06</p>	<p>Angled downward Abwärts gewinkelt Angulada hacia abajo Angulé en dessous angolata inferiormente</p>	<p>27-610-23</p>	<p>27-610-30</p>
<p>Angled upward Aufwärts gewinkelt Angulada hacia arriba Angulé au dessus angolata superiormente</p>	 <p>TISCHLER 27-610-07</p>	 <p>KEVOURKIAN YOUNGE 27-610-07</p>	<p>Straight Gerade Recta Droit Retta</p>	<p>27-610-23</p>	<p>27-610-30</p>
<p>Angled downward Abwärts gewinkelt Angulada hacia abajo Angulé en dessous angolata inferiormente</p>	 <p>TOWNSEND 27-610-05</p>	 <p>KRAUSE 27-610-06</p>	<p>Straight Gerade Recta Droit Retta</p>	<p>27-610-23</p>	<p>27-610-30</p>
<p>Straight Gerade Recta Droit Retta</p>	 <p>TOWNSEND 27-610-03</p>	 <p>SCHEINMANN 27-610-08</p>	<p>Angled downward Abwärts gewinkelt Angulada hacia abajo Angulé en dessous angolata inferiormente</p>	<p>27-610-23</p>	<p>27-610-30</p>
<p>Angled upward Aufwärts gewinkelt Angulada hacia arriba Angulé au dessus angolata superiormente</p>	 <p>TISCHLER 27-610-05</p>	 <p>SCHUMACHER 27-610-10</p>	<p>Straight Gerade Recta Droit Retta</p>	<p>27-610-23</p>	<p>27-610-30</p>

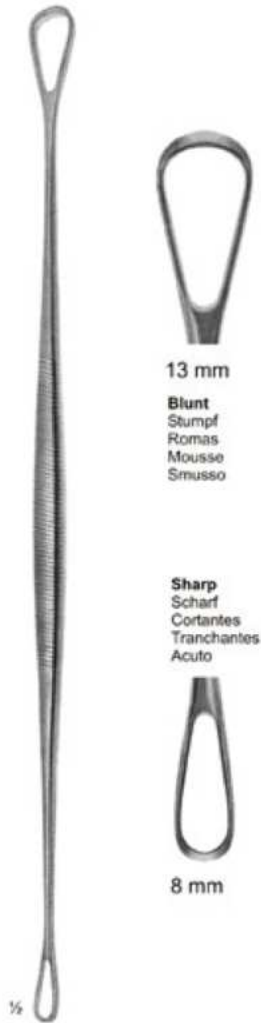

13 mm

Blunt
Stumpf
Romos
Mousse
Smusso

Sharp
Scharf
Cortantes
Tranchantes
Acuto

8 mm

BLAKE
27-622-27
27 cm, 10½"
27-622-31
31 cm, 12¼"

Uterine curette
Uteruskürette
Cureta uterina
Curette utérine
Curette uterine

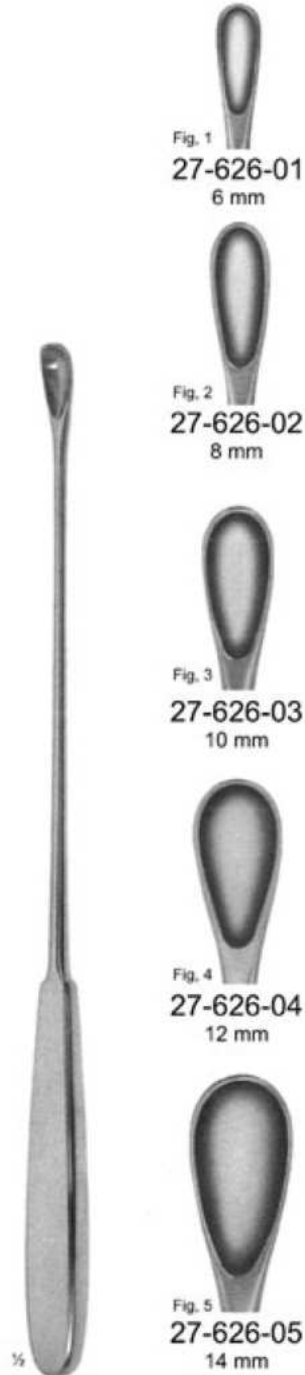

Fig. 1
27-626-01
6 mm

Fig. 2
27-626-02
8 mm

Fig. 3
27-626-03
10 mm

Fig. 4
27-626-04
12 mm

Fig. 5
27-626-05
14 mm

GOURDET
27-626-01
27-626-05
28 cm, 11"

Uterine scoops, blunt / rigid
Uteruslöffel, stumpf / fest
Cucharillas uterinas, romas / rígidas
Curettes utérines, mousses / rígides
Curette uterine, smusse / rigide

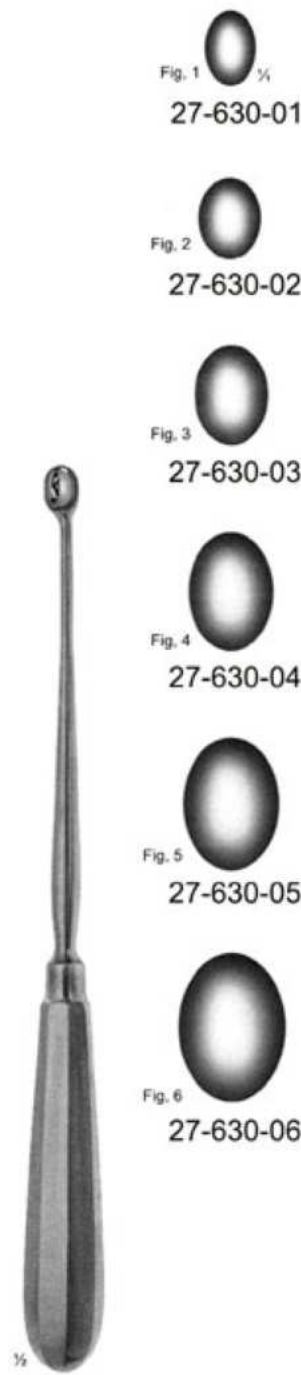

Fig. 1
27-630-01

Fig. 2
27-630-02

Fig. 3
27-630-03

Fig. 4
27-630-04

Fig. 5
27-630-05

Fig. 6
27-630-06

SIMON
27-630-01
27-630-06
25 cm, 10"

Uterine scoops, sharp / rigid
Uteruslöffel, scharf / fest
Cucharillas uterinas, cortante / rígidas
Curettes utérines, tranchantes / rígides
Curette uterine, acute / rigide

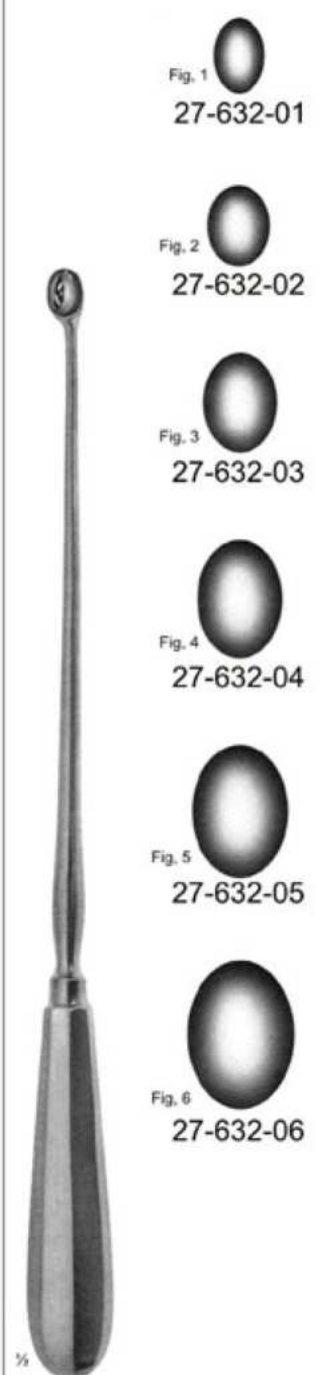

Fig. 1
27-632-01

Fig. 2
27-632-02

Fig. 3
27-632-03

Fig. 4
27-632-04

Fig. 5
27-632-05

Fig. 6
27-632-06

SCHRODER
27-632-01
27-632-06
30 cm, 12"

Uterine scoops, sharp / rigid
Uteruslöffel, scharf / fest
Cucharillas uterinas, cortante / rígidas
Curettes utérines, tranchantes / rígides
Curette uterine, acute / rigide

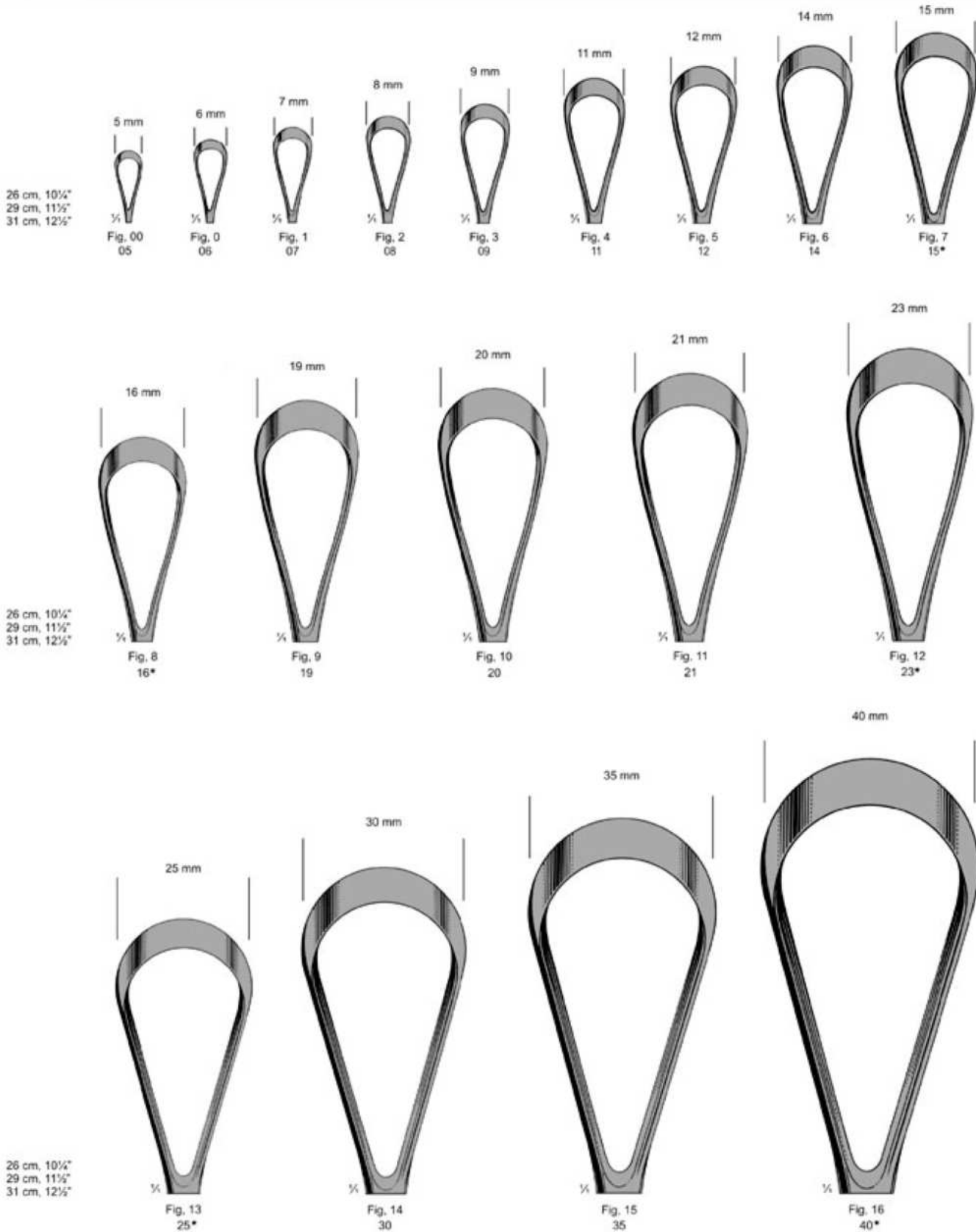



- 27-640-05 fig 00
- 27-640-06 fig 0
- 27-640-07 fig 01
- 27-640-08 fig 02
- 27-640-09 fig 03
- 27-640-11 fig 04
- 27-640-12 fig 05
- 27-640-14 fig 06
- 27-640-15 fig 07
- 27-640-16 fig 08
- 27-640-19 fig 09
- 27-640-20 fig 10
- 27-640-21 fig 11
- 27-640-23 fig 12
- 27-640-25 fig 13
- 27-640-30 fig 14
- 27-640-35 fig 15
- 27-640-40 fig 16

1/2

RECAMIER
27-640-05
27-640-40
31 cm, 12½"

Blunt, rigid
Stumpf, fest
Romas, rígidas
Mousses, rigides
Smusse, rigide



- 27-641-05 fig 00
- 27-641-06 fig 0
- 27-641-07 fig 01
- 27-641-08 fig 02
- 27-641-09 fig 03
- 27-641-11 fig 04
- 27-641-12 fig 05
- 27-641-14 fig 06
- 27-641-15 fig 07
- 27-641-16 fig 08
- 27-641-19 fig 09
- 27-641-20 fig 10
- 27-641-21 fig 11
- 27-641-23 fig 12
- 27-641-25 fig 13
- 27-641-30 fig 14
- 27-641-35 fig 15
- 27-641-40 fig 16

1/2

RECAMIER
27-641-05
27-641-40
31 cm, 12½"

sharp, malleable
scharf, biegsam
cortantes, maleables
tranchantes, malléables
acute, malleable



- 27-644-05 fig 00
- 27-644-06 fig 0
- 27-644-07 fig 01
- 27-644-08 fig 02
- 27-644-09 fig 03
- 27-644-11 fig 04
- 27-644-12 fig 05
- 27-644-14 fig 06
- 27-644-15 fig 07
- 27-644-16 fig 08
- 27-644-19 fig 09
- 27-644-20 fig 10
- 27-644-21 fig 11
- 27-644-23 fig 12
- 27-644-25 fig 13
- 27-644-30 fig 14
- 27-644-35 fig 15
- 27-644-40 fig 16

1/2

RECAMIER
27-644-05
27-644-40
31 cm, 12½"

Blunt, rigid
Stumpf, fest
Romas, rígidas
Mousses, rigides
Smusse, rigide



- 27-645-05 fig 00
- 27-645-06 fig 0
- 27-645-07 fig 01
- 27-645-08 fig 02
- 27-645-09 fig 03
- 27-645-11 fig 04
- 27-645-12 fig 05
- 27-645-14 fig 06
- 27-645-15 fig 07
- 27-645-16 fig 08
- 27-645-19 fig 09
- 27-645-20 fig 10
- 27-645-21 fig 11
- 27-645-23 fig 12
- 27-645-25 fig 13
- 27-640-30 fig 14
- 27-640-35 fig 15
- 27-640-40 fig 16

1/2

RECAMIER
27-645-05
27-645-40
31 cm, 12½"

sharp, malleable
scharf, biegsam
cortantes, maleables
tranchantes, malléables
acute, malleable



- 27-650-05 fig 00
- 27-650-06 fig 0
- 27-650-07 fig 01
- 27-650-08 fig 02
- 27-650-09 fig 03
- 27-650-11 fig 04
- 27-650-12 fig 05
- 27-650-14 fig 06
- 27-650-15 fig 07
- 27-650-16 fig 08
- 27-650-19 fig 09
- 27-650-20 fig 10
- 27-650-21 fig 11
- 27-650-23 fig 12
- 27-650-25 fig 13
- 27-650-30 fig 14
- 27-650-35 fig 15
- 27-650-40 fig 16

1/2

SIMS
27-650-05
27-650-40
31 cm, 12½"

Blunt, rigid
Stumpf, fest
Romos, rígidas
Mousses, rigides
Smusse, rigide



- 27-651-05 fig 00
- 27-651-06 fig 0
- 27-651-07 fig 01
- 27-651-08 fig 02
- 27-651-09 fig 03
- 27-651-11 fig 04
- 27-651-12 fig 05
- 27-651-14 fig 06
- 27-651-15 fig 07
- 27-651-16 fig 08
- 27-651-19 fig 09
- 27-651-20 fig 10
- 27-651-21 fig 11
- 27-651-23 fig 12
- 27-651-25 fig 13
- 27-651-30 fig 14
- 27-651-35 fig 15
- 27-651-40 fig 16

1/2

SIMS
27-651-05
27-651-40
31 cm, 12½"

sharp, malleable
scharf, biegsam
cortantes, maleables
tranchantes, malléables
acuto, malleable



- 27-654-05 fig 00
- 27-654-06 fig 0
- 27-654-07 fig 01
- 27-654-08 fig 02
- 27-654-09 fig 03
- 27-654-11 fig 04
- 27-654-12 fig 05
- 27-654-14 fig 06
- 27-654-15 fig 07
- 27-654-16 fig 08
- 27-654-19 fig 09
- 27-654-20 fig 10
- 27-654-21 fig 11
- 27-654-23 fig 12
- 27-654-25 fig 13
- 27-654-30 fig 14
- 27-654-35 fig 15
- 27-654-40 fig 16

1/2

SIMS
27-654-05
27-654-40
31 cm, 12½"

Blunt, rigid
Stumpf, fest
Romos, rígidas
Mousses, rigides
Smusse, rigide



- 27-655-05 fig 00
- 27-655-06 fig 0
- 27-655-07 fig 01
- 27-655-08 fig 02
- 27-655-09 fig 03
- 27-655-11 fig 04
- 27-655-12 fig 05
- 27-655-14 fig 06
- 27-655-15 fig 07
- 27-655-16 fig 08
- 27-655-19 fig 09
- 27-655-20 fig 10
- 27-655-21 fig 11
- 27-655-23 fig 12
- 27-655-25 fig 13
- 27-655-30 fig 14
- 27-655-35 fig 15
- 27-655-40 fig 16

1/2

SIMS
27-655-05
27-655-40
31 cm, 12½"

sharp, malleable
scharf, biegsam
cortantes, maleables
tranchantes, malléables
acuto, malleable



- 27-660-05 fig 00
- 27-660-06 fig 0
- 27-660-07 fig 01
- 27-660-08 fig 02
- 27-660-09 fig 03
- 27-660-11 fig 04
- 27-660-12 fig 05
- 27-660-14 fig 06
- 27-660-15 fig 07
- 27-660-16 fig 08
- 27-660-19 fig 09
- 27-660-20 fig 10
- 27-660-21 fig 11
- 27-660-23 fig 12
- 27-660-25 fig 13
- 27-660-30 fig 14
- 27-660-35 fig 15
- 27-660-40 fig 16

½

BUMM
27-660-05
27-660-40
29 cm, 11½"

Blunt, rigid
Stumpf, fest
Romos, rígidas
Mousses, rigides
Smusse, rigide



- 27-661-05 fig 00
- 27-661-06 fig 0
- 27-661-07 fig 01
- 27-661-08 fig 02
- 27-661-09 fig 03
- 27-661-11 fig 04
- 27-661-12 fig 05
- 27-661-14 fig 06
- 27-661-15 fig 07
- 27-661-16 fig 08
- 27-661-19 fig 09
- 27-661-20 fig 10
- 27-661-21 fig 11
- 27-661-23 fig 12
- 27-661-25 fig 13
- 27-661-30 fig 14
- 27-661-35 fig 15
- 27-661-40 fig 16

½

BUMM
27-661-05
27-661-40
29 cm, 11½"

sharp, malleable
scharf, biegsam
cortantes, maleables
tranchantes, malléables
acute, malleabile



- 27-664-05 fig 00
- 27-664-06 fig 0
- 27-664-07 fig 01
- 27-664-08 fig 02
- 27-664-09 fig 03
- 27-664-11 fig 04
- 27-664-12 fig 05
- 27-664-14 fig 06
- 27-664-15 fig 07
- 27-664-16 fig 08
- 27-664-19 fig 09
- 27-664-20 fig 10
- 27-664-21 fig 11
- 27-664-23 fig 12
- 27-664-25 fig 13
- 27-664-30 fig 14
- 27-664-35 fig 15
- 27-664-40 fig 16

½

BUMM
27-664-05
27-664-40
29 cm, 11½"

Blunt, rigid
Stumpf, fest
Romos, rígidas
Mousses, rigides
Smusse, rigide



- 27-665-05 fig 00
- 27-665-06 fig 0
- 27-665-07 fig 01
- 27-665-08 fig 02
- 27-665-09 fig 03
- 27-665-11 fig 04
- 27-665-12 fig 05
- 27-665-14 fig 06
- 27-665-15 fig 07
- 27-665-16 fig 08
- 27-665-19 fig 09
- 27-665-20 fig 10
- 27-665-21 fig 11
- 27-665-23 fig 12
- 27-665-25 fig 13
- 27-665-30 fig 14
- 27-665-35 fig 15
- 27-665-40 fig 16

½

BUMM
27-665-05
27-665-40
29 cm, 11½"

sharp, malleable
scharf, biegsam
cortantes, maleables
tranchantes, malléables
acute, malleabile



27-666-03
28,5 cm, 11¼"



27-666-04
28,5 cm, 11¼"



27-666-06
28,5 cm, 11¼"



27-666-08
28,5 cm, 11¼"



27-666-10
28,5 cm, 11¼"

Specimen and aspirating curettes
Probe-und absaugküretten
Curetas de biopsia y de aspiracion
Curettes à biopsie et d'aspiration
Curette per prelievo ed aspirazione

Aspirating curettes
Absaugküretten
Curetas de aspiracion
Curettes d'aspiration
Curette per aspirazione



ø 12 mm



ø 14 mm



27-666-12
28,5 cm, 11¼"



27-666-14
28,5 cm, 11¼"



1/8"

27-680-00

Coupling piece for the connection of aspirating currettes 27-666-03_27-666-14 to flexible tube having an interior diameter of 11 mm

Schlauchverbindungsstück für Absaugküretten 27-666-03 bis 27-666-14, für Saugschlauch von 11 mm Innen-ø

Adaptador de tubo para curetas de aspiración 27-666-03-27-666-14 para tubos de aspiración. Ø interior de 11 mm

Embout adaptable aux currettes 27-666-03_27-666-14 pour tube d'aspiration, ø inférieur à 11 mm

Adattatore per la connessione delle curette per aspirazione 27-666-03_27-666-14 ad un tubo flessibile avente un ø int. di 11 mm



Fig. 1

27-690-01
10mm



Fig. 2

27-690-02
12mm



Fig. 3

27-690-03
14mm



GREENE
27-690-01
27-690-03
28 cm, 11½"