

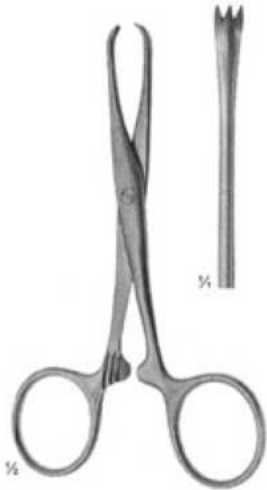

Intestines, Stomach, Rectum
Darm, Magen, Mastdarm
Intestino, Estómago, Recto
Intestins, Estomac, Rectum
Intestino, Stomaco, Retto



CHAPUT
23-106-13
13 cm, 5"

2x3 Teeth
2x3 Zähne
2x3 Dientes
2x3 Dents
2x3 Denti



BABY-ALLIS
23-108-12
23-108-14

4x5 Teeth
4x5 Zähne
4x5 Dientes
4x5 Dents
4x5 Denti



ALLIS
23-110-15
23-112-19

4x5 Teeth
4x5 Zähne
4x5 Dientes
4x5 Dents
4x5 Denti

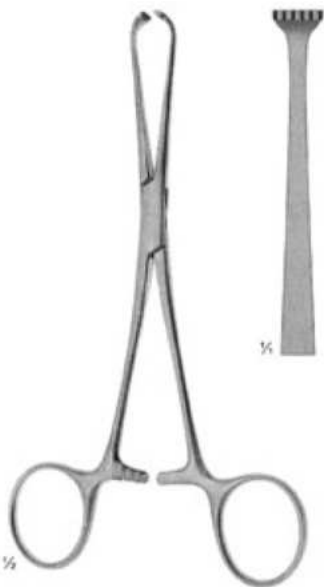

BOYS-ALLIS
23-114-15
15 cm, 6"

4x5 Teeth
4x5 Zähne
4x5 Dientes
4x5 Dents
4x5 Denti



ADAIR-ALLIS
23-116-15
15,5 cm, 6"

10x11 Teeth
10x11 Zähne
10x11 Dientes
10x11 Dents
10x11 Denti

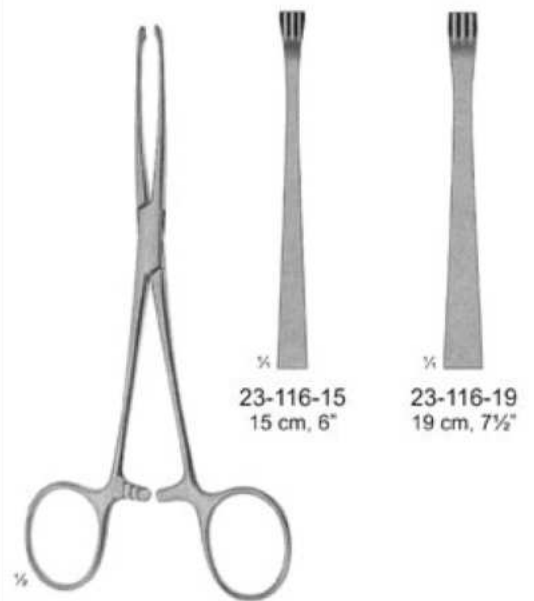

JUDD-ALLIS
23-118-15
23-118-19

3x4 Teeth
3x4 Zähne
3x4 Dientes
3x4 Dents
3x4 Denti

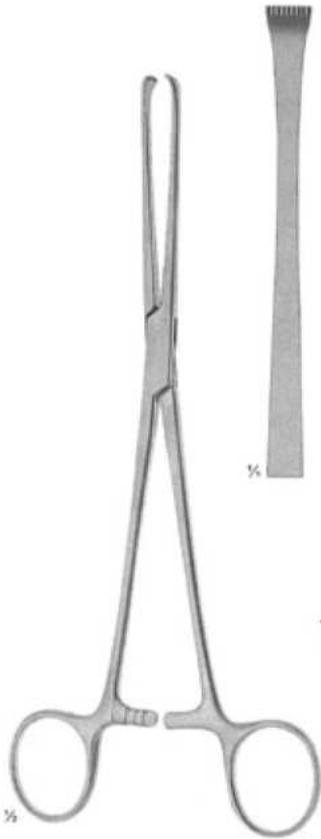
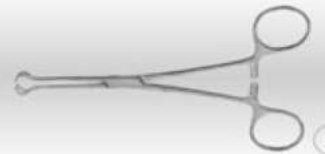

THOMS-ALLIS
23-120-20
20 cm, 8"

8x9 Teeth
8x9 Zähne
8x9 Dientes
8x9 Dents
8x9 Denti



ALLIS
23-130-23
23-130-25



23-130-23
23 cm, 9"

5x6 Teeth
5x6 Zähne
5x6 Dientes
5x6 Dents
5x6 Denti



23-130-25
25 cm, 10"

5x6 Teeth
5x6 Zähne
5x6 Dientes
5x6 Dents
5x6 Denti



BABCOCK
23-138-14
23-138-24

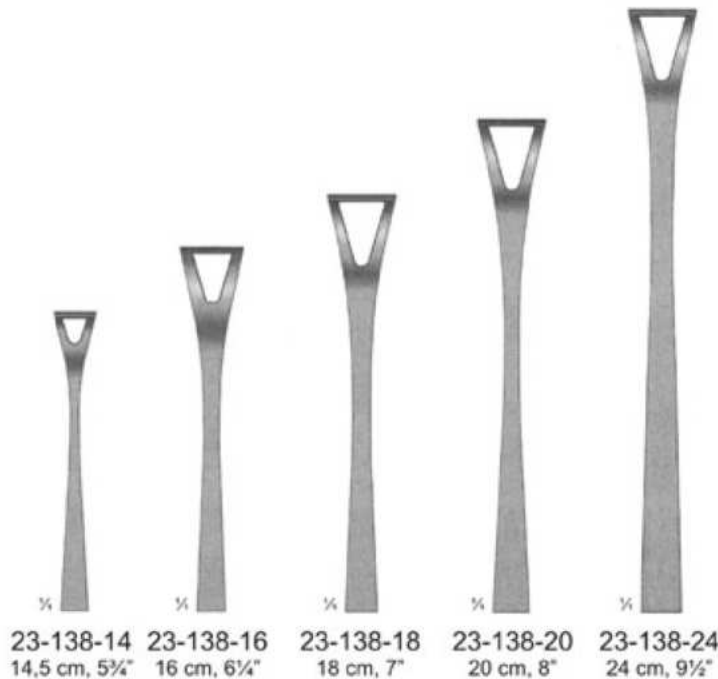

23-138-14
14,5 cm, 5 1/2"

23-138-16
16 cm, 6 1/4"

23-138-18
18 cm, 7"

23-138-20
20 cm, 8"

23-138-24
24 cm, 9 1/2"



COLLIN
23-144-14
14 cm, 5 1/2"

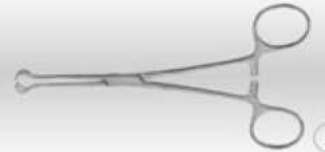

23-150-20
20 cm, 8"



23-152-20
20 cm, 8"

DUVAL
23-150-20
23-152-20



23-154-23
23 cm, 9"



23-156-23
23 cm, 9"

DUVAL
23-154-23
23-156-23



23-160-20
20 cm, 8"



23-162-20
20 cm, 8"



23-164-23
23 cm, 9"



23-166-23
23 cm, 9"



DUVAL
23-160-20
23-166-23

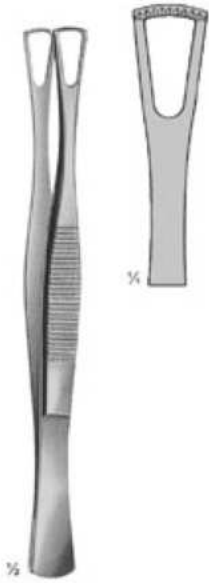
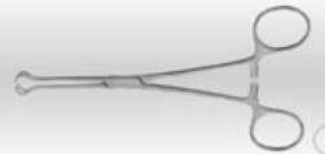

DUVAL
23-170-14
14,5 cm, 5½"



PENNINGTON
23-174-15
23-174-20

23-174-15
15,5 cm, 6"



23-174-20
20 cm, 8"

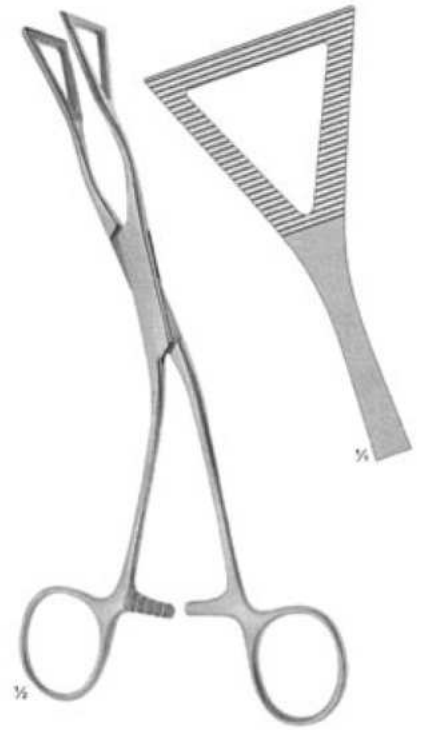

LOVELACE
23-177-20
20 cm, 8"

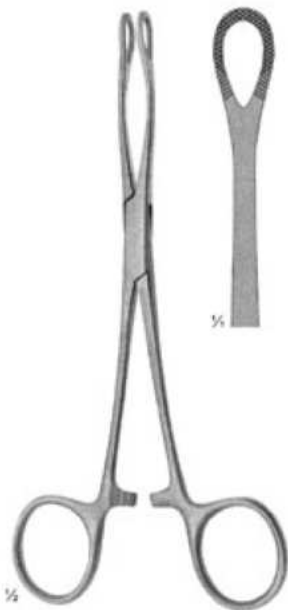

WILLIAMS
23-180-16
16 mm, 6¼"

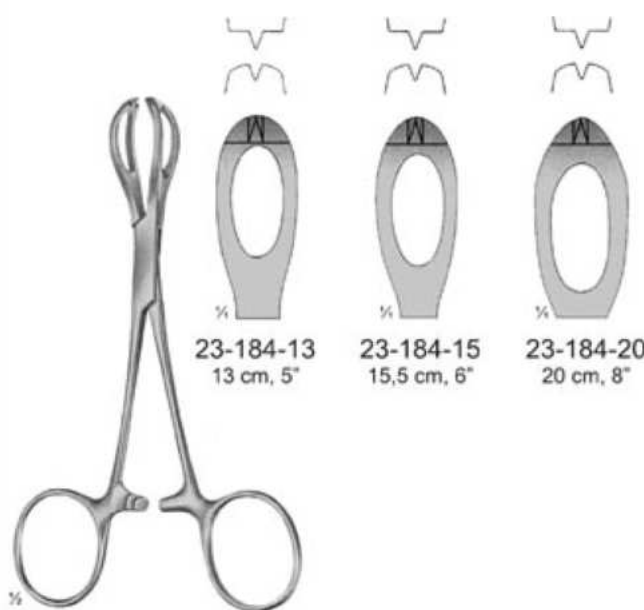

LANE
23-184-13
23-184-20

23-184-13
13 cm, 5"

23-184-15
15,5 cm, 6"

23-184-20
20 cm, 8"

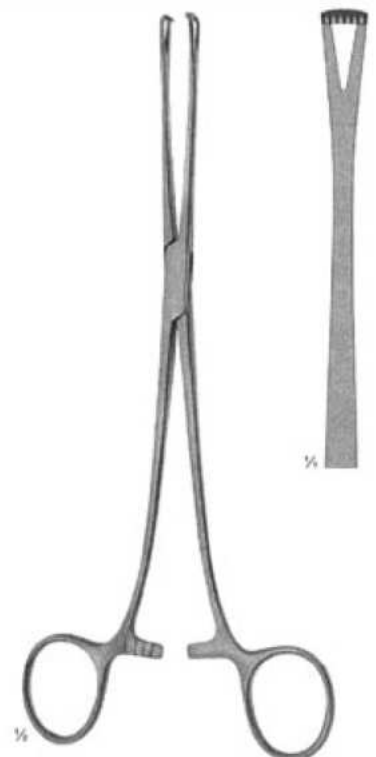

LOCKWOOD
23-188-20
20 cm, 8"

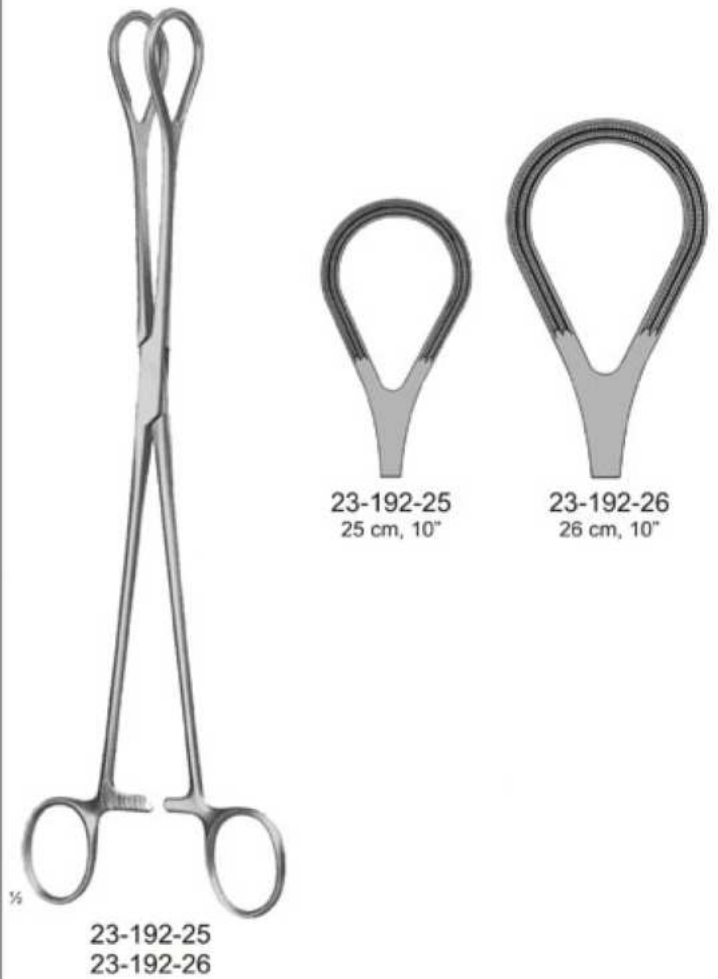
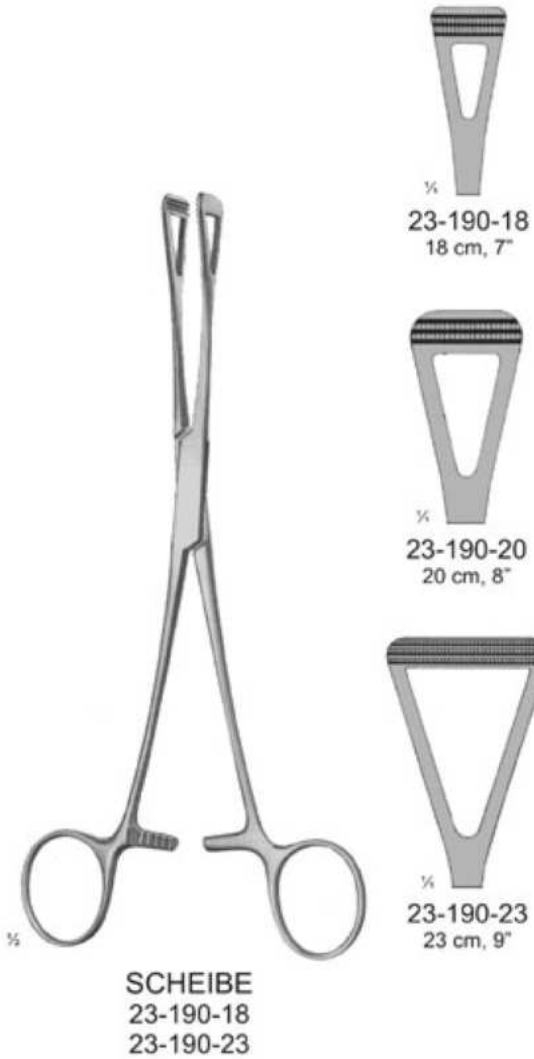

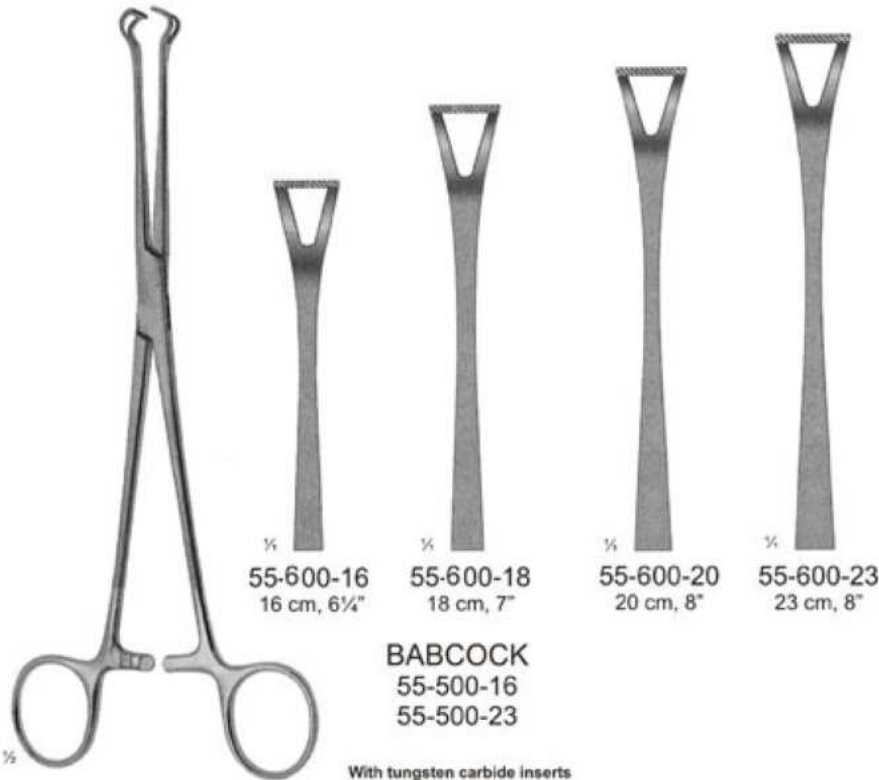

55-600-16
16 cm, 6 1/4"

55-600-18
18 cm, 7"

55-600-20
20 cm, 8"

55-600-23
23 cm, 8"

BABCOCK
55-500-16
55-500-23

With tungsten carbide inserts
Mit Hartmetalleinlagen
Con bocas de carburo tungsteno
Avec mors en tungstène
Con morsi in carburo di tungsteno



With tungsten carbide inserts
Mit Hartmetalleinlagen
Con bocas de carburo tungsteno
Avec mors en tungstène
Con morsi in carburo di tungsteno

DUVAL
55-602-20
20 cm, 8"

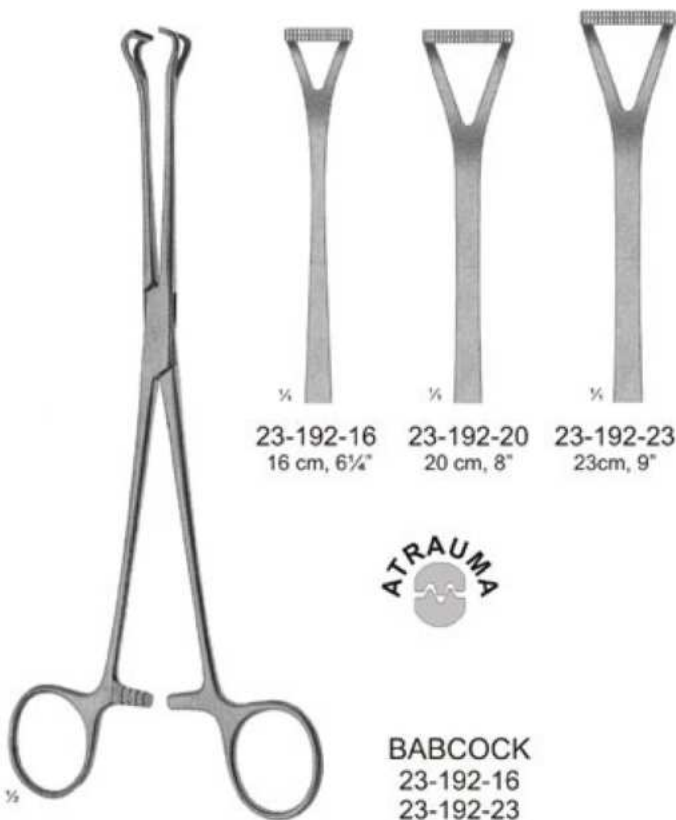

23-192-16
16 cm, 6 1/4"

23-192-20
20 cm, 8"

23-192-23
23cm, 9"



BABCOCK
23-192-16
23-192-23

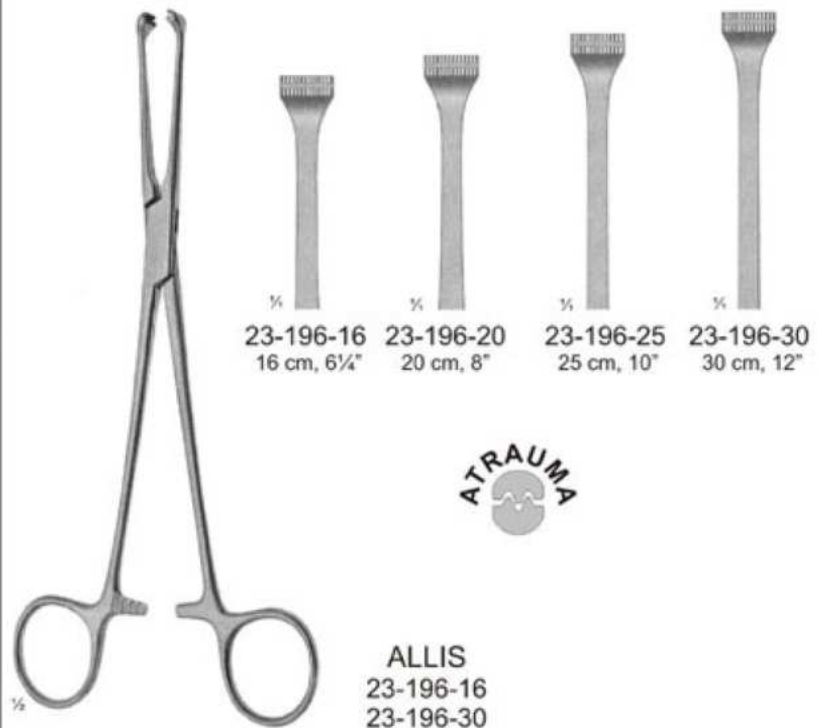

23-196-16
16 cm, 6 1/4"

23-196-20
20 cm, 8"

23-196-25
25 cm, 10"

23-196-30
30 cm, 12"



ALLIS
23-196-16
23-196-30

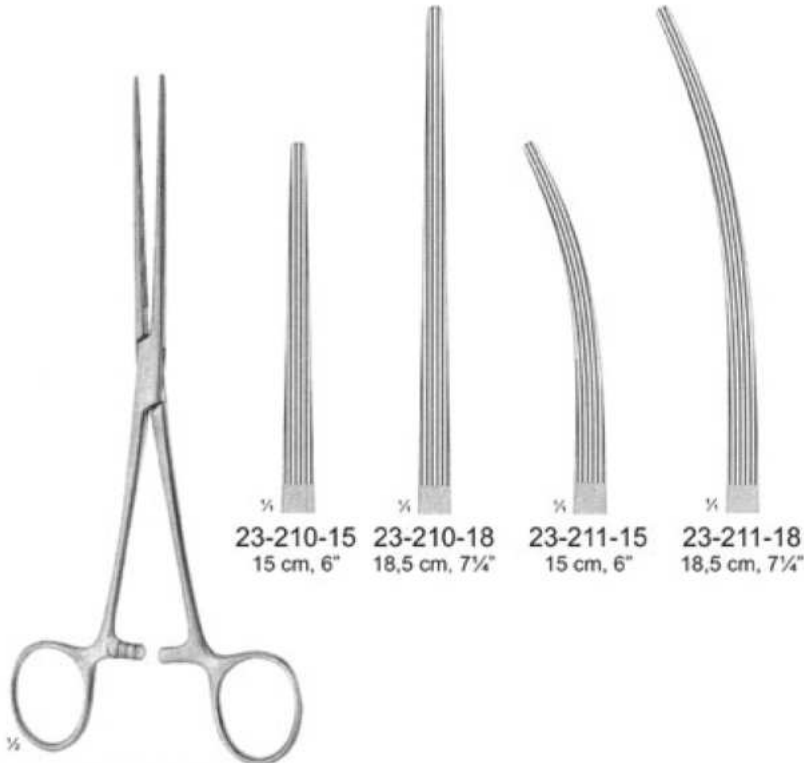
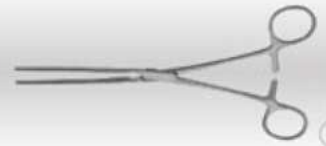

23-210-15
15 cm, 6"

23-210-18
18,5 cm, 7 1/4"

23-211-15
15 cm, 6"

23-211-18
18,5 cm, 7 1/4"

BAINBRIDGE
23-210-15
23-211-18

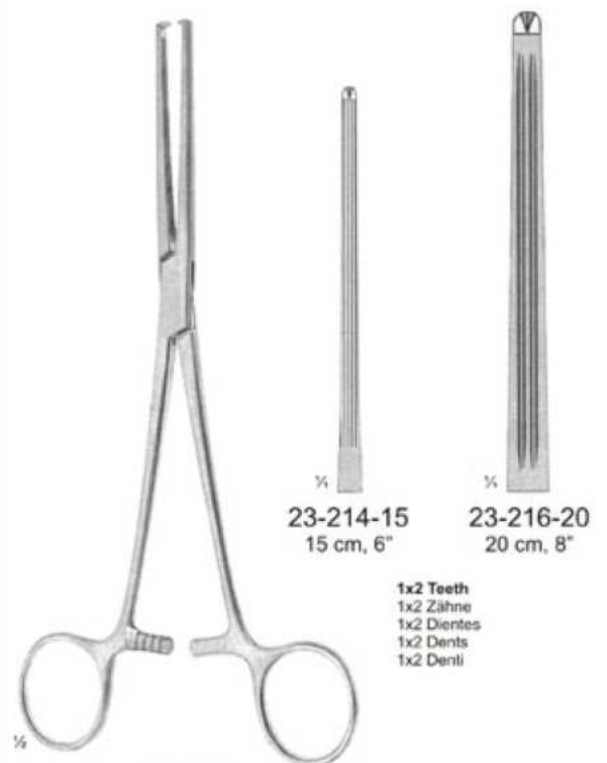

23-214-15
15 cm, 6"

23-216-20
20 cm, 8"

1x2 Teeth
1x2 Zähne
1x2 Dientes
1x2 Dents
1x2 Dentli

ALLEN
23-214-15
23-216-20



1x2 Teeth
1x2 Zähne
1x2 Dientes
1x2 Dents
1x2 Dentli

REDO
23-220-20
20 cm, 8"

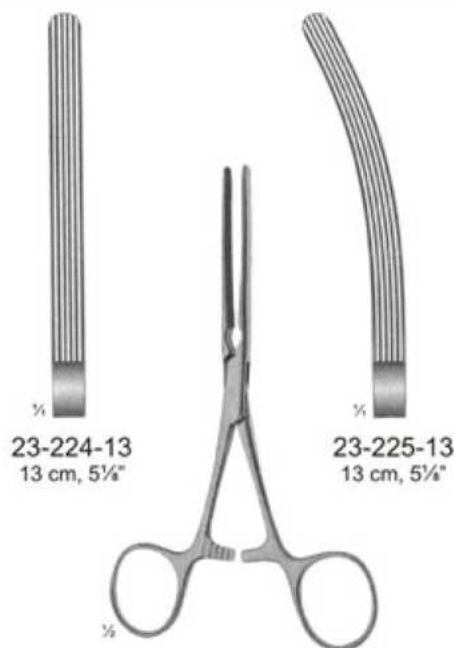

23-224-13
13 cm, 5 1/4"

23-225-13
13 cm, 5 1/4"

BABY-KOCHER
23-224-13
23-225-13

Soft elastic
Weich federnd
elásticas (suave)
souples
leggermente elastica

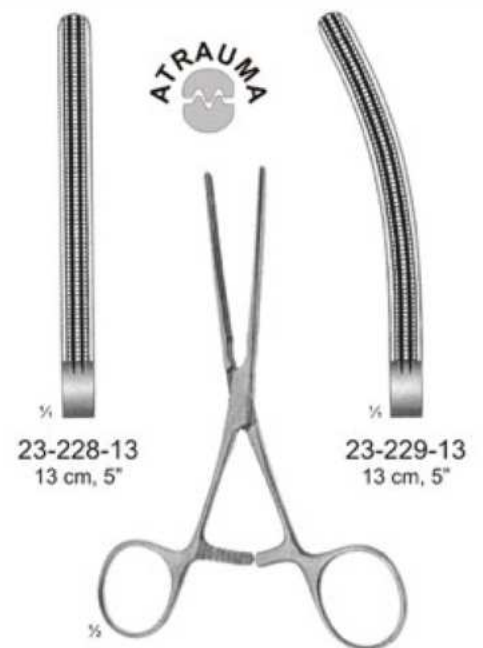

23-228-13
13 cm, 5"

23-229-13
13 cm, 5"

BABY-KOCHER
23-228-13
23-229-13

Soft elastic
Weich federnd
elásticas (suave)
souples
leggermente elastica



KOCHER
23-232-21
23-233-28



23-232-21
21 cm, 8½"



23-232-23
23 cm, 9"



23-232-28
28 cm, 11"



23-233-21
21 cm, 8½"



23-233-23
23 cm, 9"



23-233-28
28 cm, 11"

Soft elastic
Weich federnd
elásticas (suave)
souples
leggermente elastica

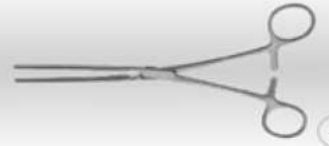

KOCHER
23-236-22
23-237-28

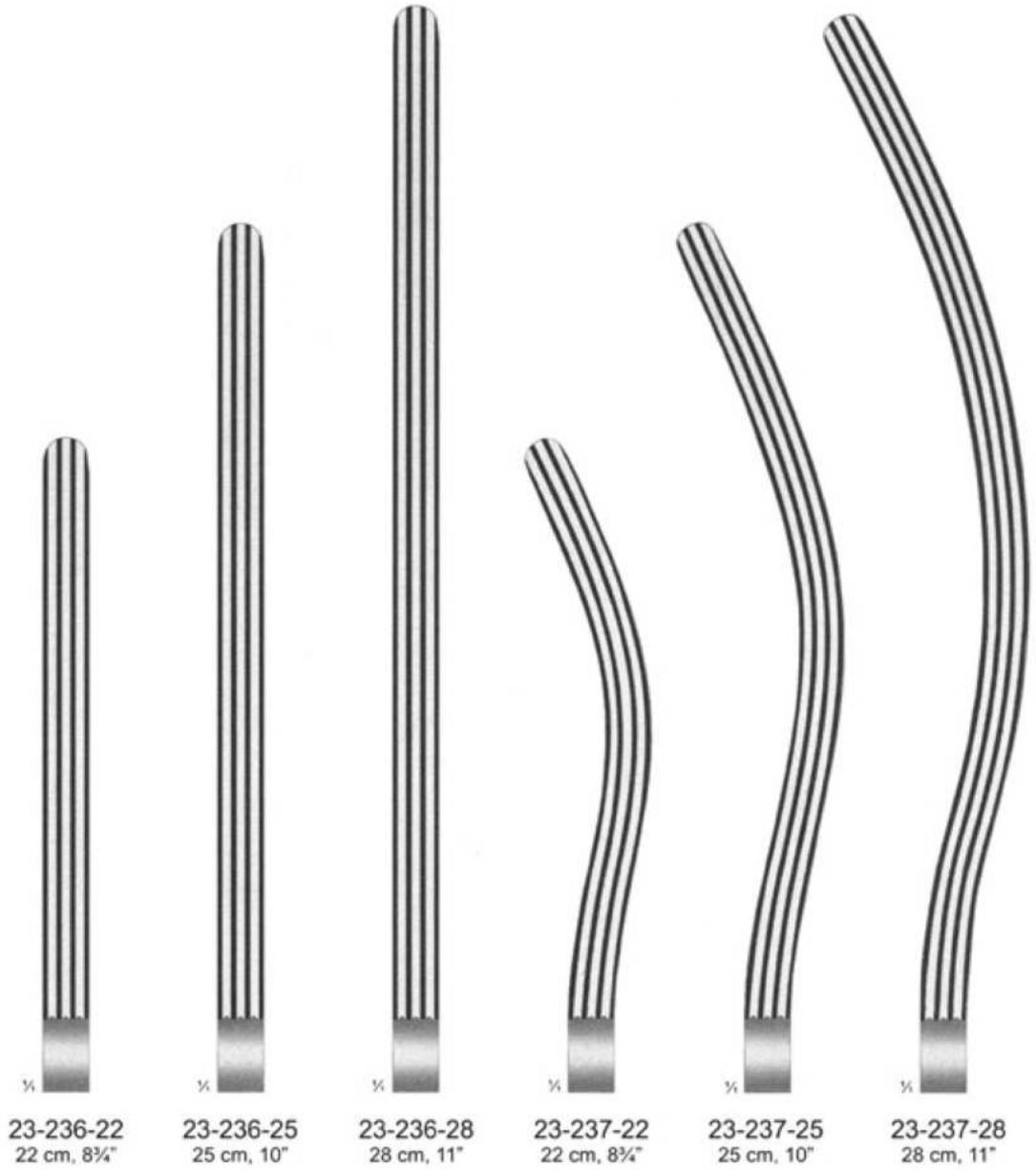

Soft elastic
Weich federnd
elásticas (suave)
souples
leggermente elastica

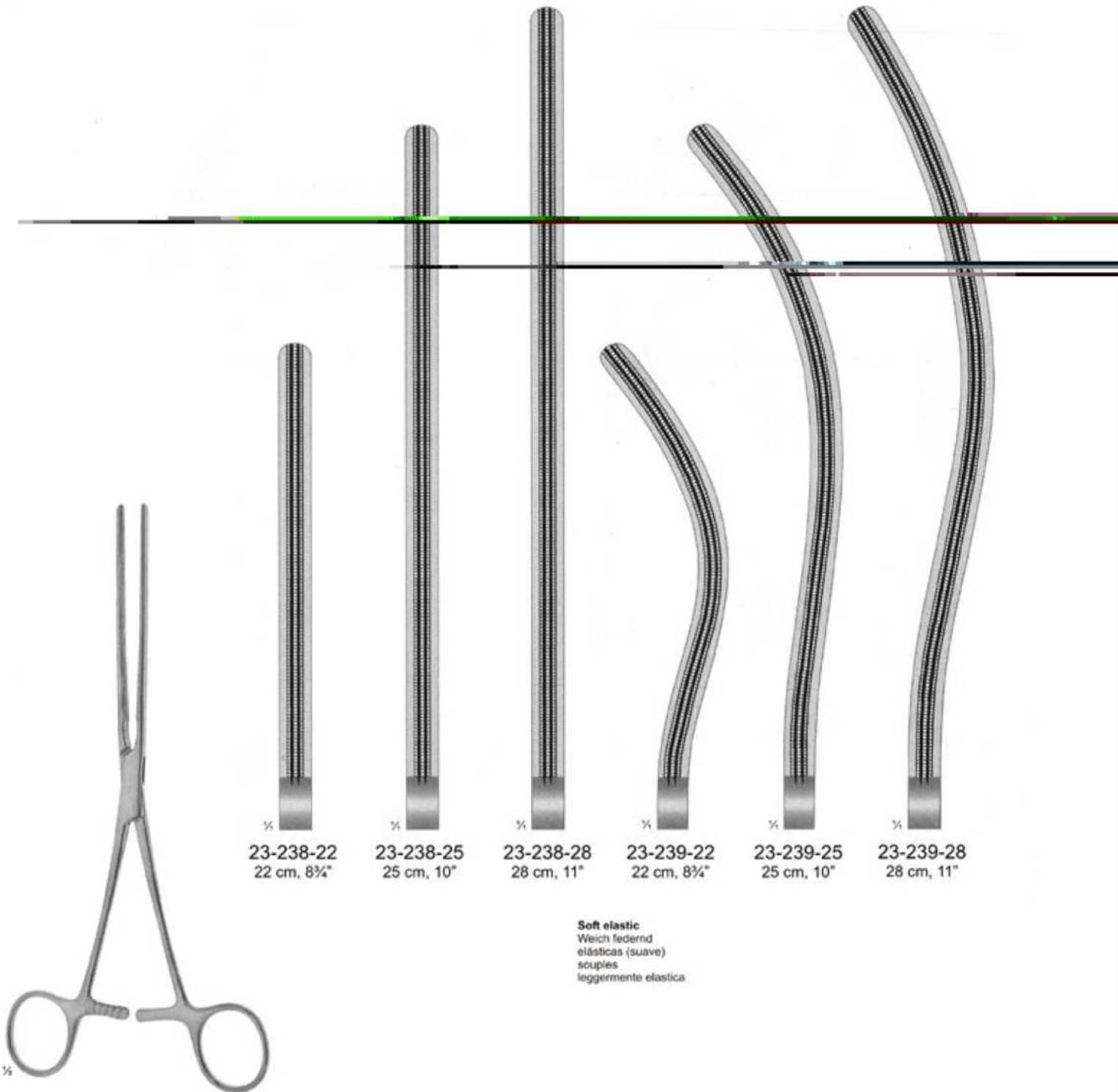

23-238-22
22 cm, 8¾"

23-238-25
25 cm, 10"

23-238-28
28 cm, 11"

23-239-22
22 cm, 8¾"

23-239-25
25 cm, 10"

23-239-28
28 cm, 11"

Soft elastic
Weich federnd
elásticas (suave)
souples
leggermente elastica

KOCHER
23-238-22
23-239-28



DOYEN
23-244-13
23-245-23

Soft elastic
Weich federnd
elásticas (suave)
souples
leggermente elastica



23-244-13
13 cm, 5"



23-244-16
16 cm, 6¼"



23-244-18
18 cm, 7"



23-244-21
21 cm, 8¼"



23-244-23
23 cm, 9"



23-245-13
13 cm, 5"



23-245-16
16 cm, 6¼"



23-245-18
18 cm, 5"



23-245-21
21 cm, 8¼"

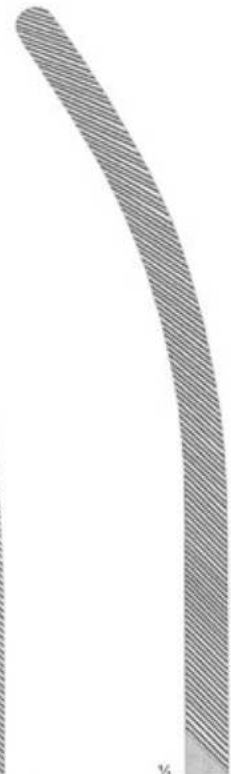

23-245-23
23 cm, 9"



With non-traumatic serration
Mit atraumatischer Riefung
Con bocas atraumáticas
Avec mors atraumatiques
Con presa atraumatica



DOYEN
23-248-13
23-249-23

Soft elastic
Weich federnd
elásticas (suave)
souples
leggermente elastica



23-248-13
13 cm, 5"



23-248-16
16 cm, 6 1/4"



23-248-18
18 cm, 7"



23-248-21
21 cm, 8 1/4"



23-248-23
23 cm, 9"



23-249-13
13cm, 5"



23-249-16
16cm, 6 1/4"



23-249-18
18cm, 7"



23-249-21
21 cm, 8 1/4"



23-249-23
23 cm, 9"

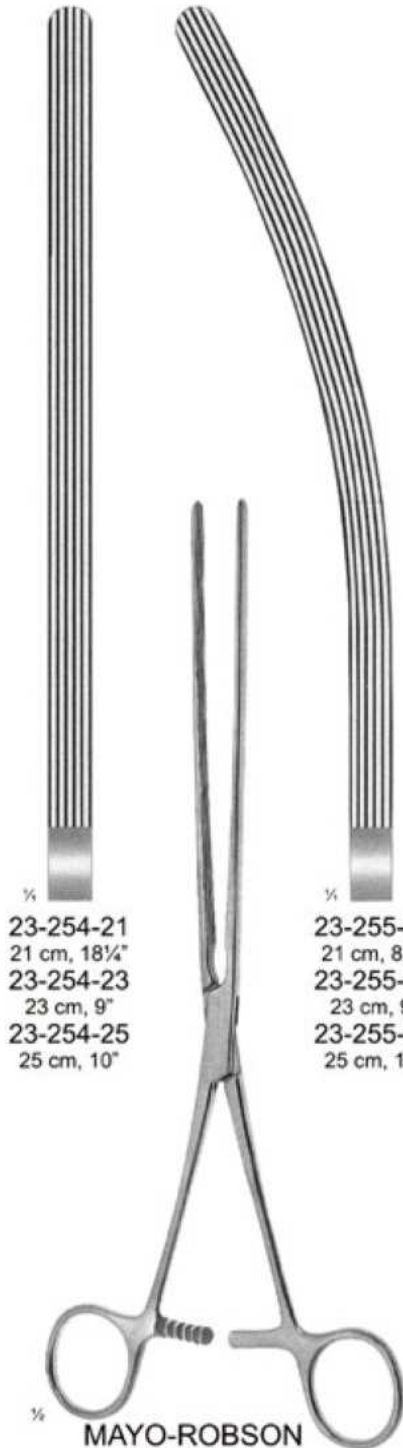
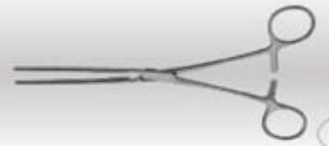

23-254-21
21 cm, 18 1/4"
23-254-23
23 cm, 9"
23-254-25
25 cm, 10"

23-255-21
21 cm, 8 1/4"
23-255-23
23 cm, 9"
23-255-25
25 cm, 10"

MAYO-ROBSON
23-254-21
23-255-25

Hard elastic with non-traumatic serration
hart fedemd, mit atraumatischer riefung
elásticas (duro), con bocas atraumáticas
fermes, avec mors atrauma
elastica duro, con morsi atraumatici

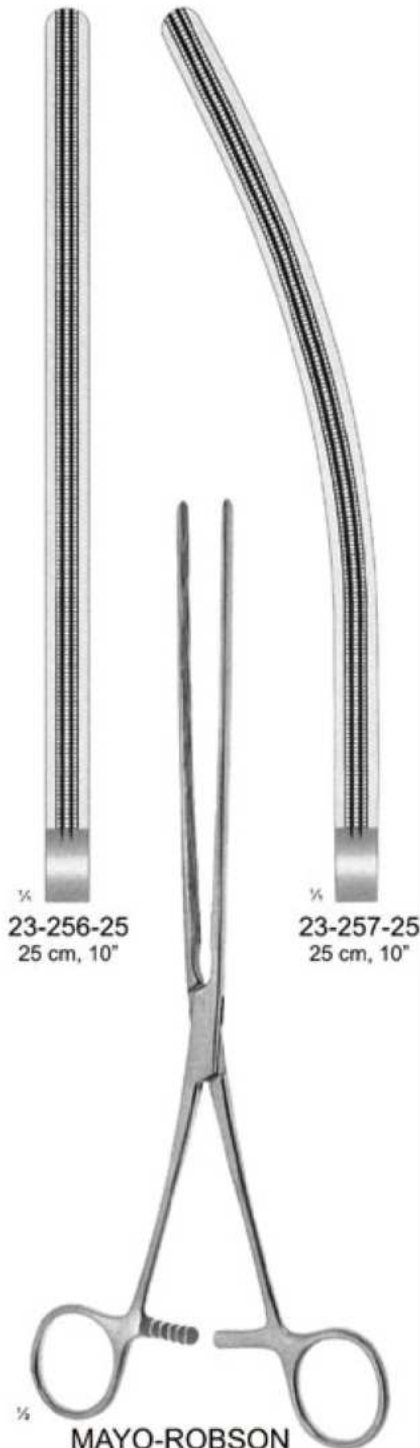

23-256-25
25 cm, 10"

23-257-25
25 cm, 10"

MAYO-ROBSON
23-256-25
23-257-25

Hard elastic with non-traumatic serration
hart fedemd, mit atraumatischer riefung
elásticas (duro), con bocas atraumáticas
fermes, avec mors atrauma
elastica duro, con morsi atraumatici

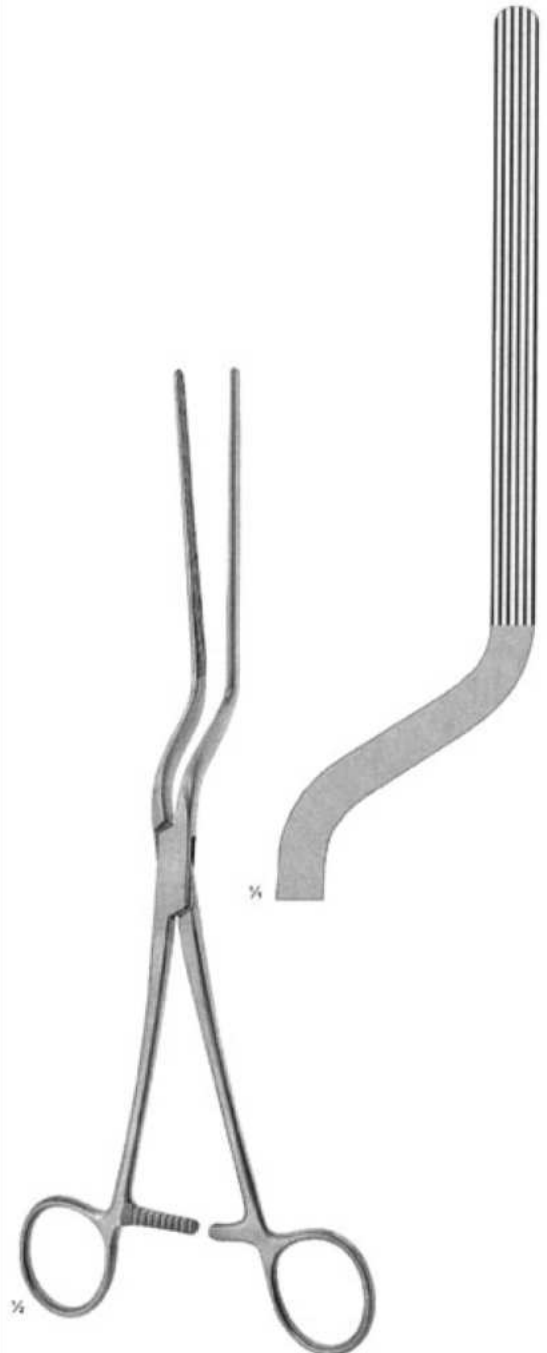

BRUNNER
23-260-24
24 cm, 9 1/2"

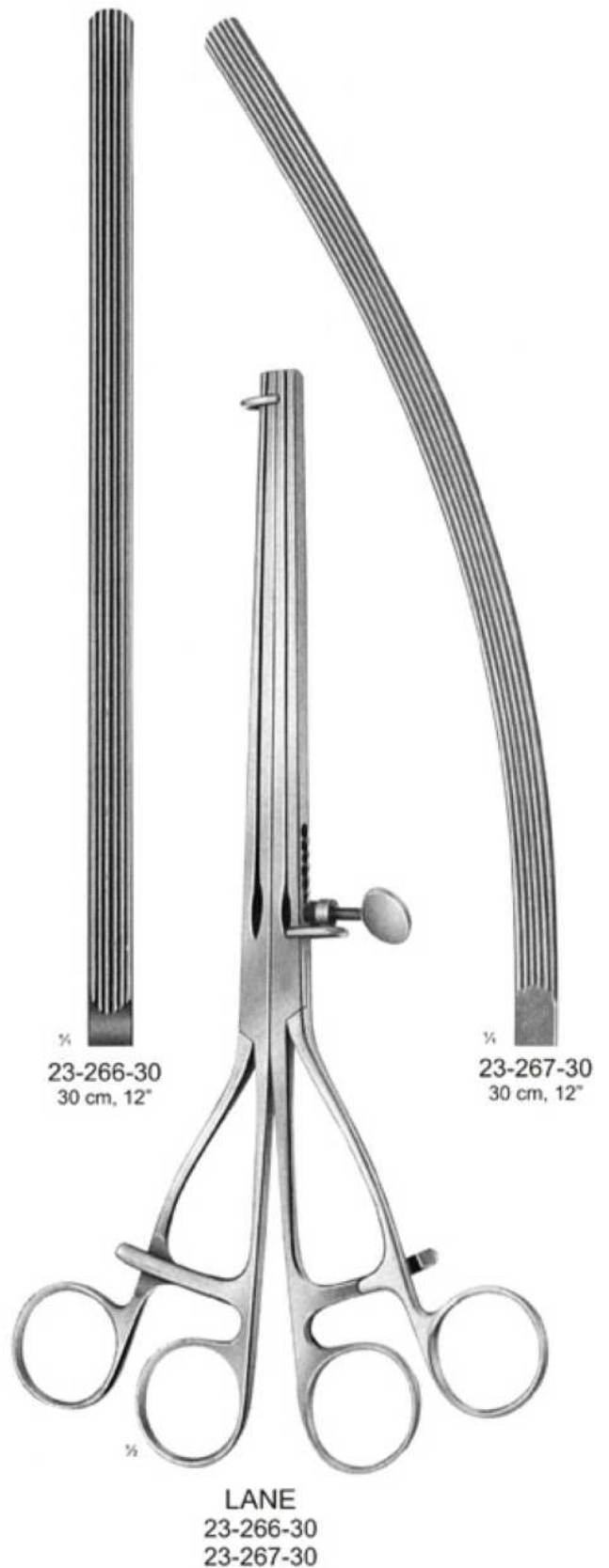
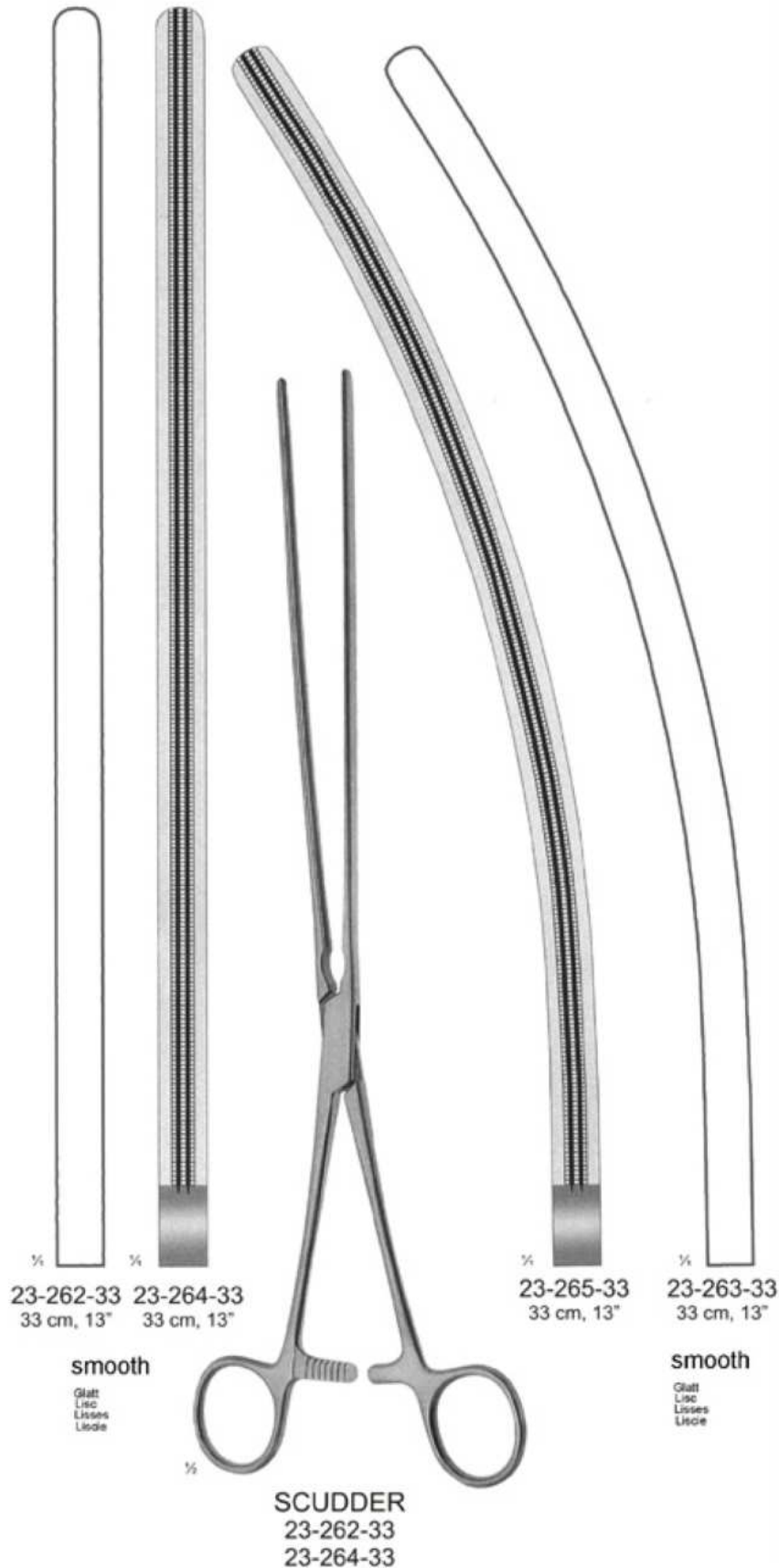



23-273-24
24 cm, 9½"

23-275-24
24 cm, 9½"

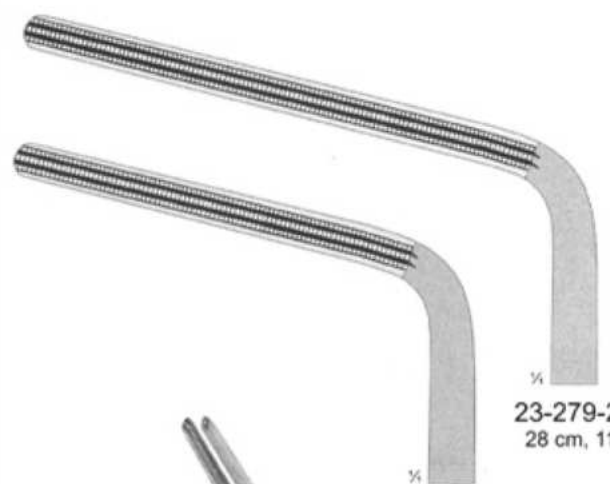

23-277-26
26 cm, 10¼"

23-279-28
28 cm, 11"



FEHLAND
23-273-24
23-275-24



HAYES
23-277-26
23-279-28

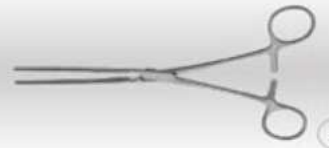

VEIDENHEIMER
 23-283-23
 23 cm, 9"

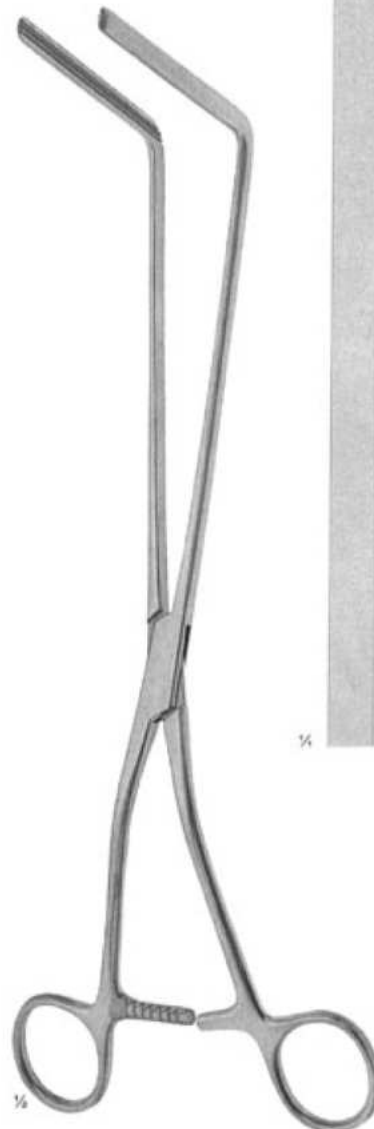

RESANO
 23-285-30
 30 cm, 12"



Clamp closing forceps
 Klemmschließzange
 Pinza para cerrar los clamps
 Pince pour fermer les clamps
 Serrapinze

DE MARTEL-WOLFSON
 23-288-26
 26 cm, 10 1/4"



**Spur crusher and
appendectomy clamp**
Spornquetsche und
appendektomieklammer
Machadora para espora y
clamp para apendectomia
Ecraseur et clamp à
appendicectomie
Pinza schiaccia sperone e
clamp per appendicectomia

KLEINSCHMIDT
23-294-12
12,5 cm, 5"



PAYR-BABY



23-300-15
15 cm, 6"



PAYR
23-300-15
23-300-35



23-300-21
21 cm, 8¼"



23-300-29
29 cm, 11½"

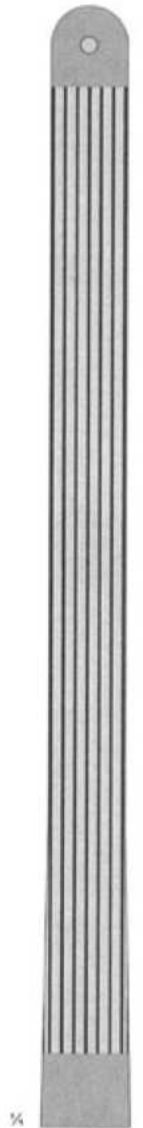

23-300-35
35 cm, 13¼"

Intestinal and stomach clamps with pin
Darm- und Magenquetschklemmen mit Stift
Pinzas-clamps intestinales y estomacales con espiga
Pince-clamps et écraseurs pour l'intestin et l'estomac avec pointe
Clamp per intestino e stomaco con perno



Pylorus spreader
Pyloruspreizer
Separador para piloro
Ecarteur du pylore
Divaricatore per piloro

BABY BENSON
23-296-15
15,5 cm, 6"





Anoscopes
Anuskope
Anoscopios
Anusopes
Anoscopi

HIRSCHMANN

- 23-330-01 16 mm x 65 mm
- 23-330-02 19 mm x 65 mm
- 23-330-03 22 mm x 65 mm
- 23-330-04 22 mm x 65 mm



Anoscope with vulcanite obturator

Anoskop mit Hartgummi-Obturator

Anoscopio con obturador de plástico

Anusopes avec obturateur en ébonite

Anoscopi con otturatore di ebanite

IVES-FANSLER

- 23-332-01 22 mm x 80 mm



NEWMAN

- 23-334-01 16mm x 63mm
- 23-334-02 19mm x 63mm
- 23-334-03 23mm x 63mm

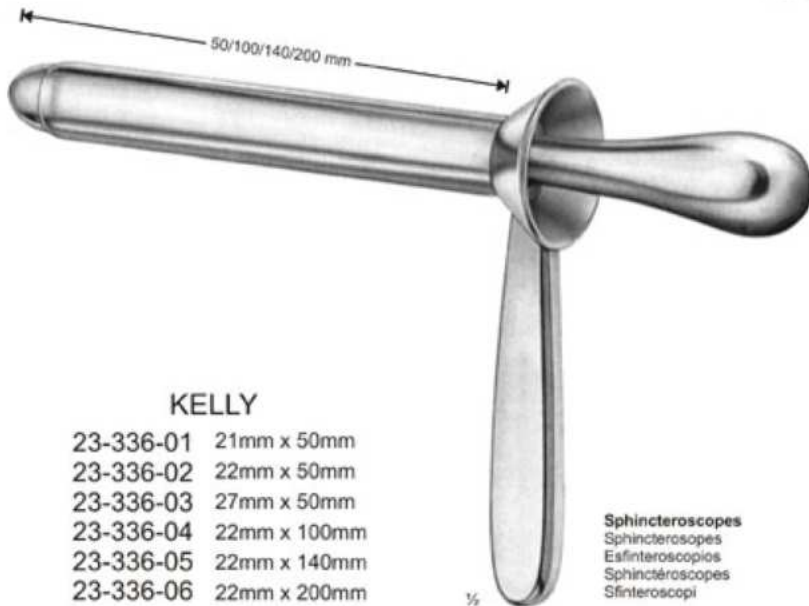

KELLY

- 23-336-01 21mm x 50mm
- 23-336-02 22mm x 50mm
- 23-336-03 27mm x 50mm
- 23-336-04 22mm x 100mm
- 23-336-05 22mm x 140mm
- 23-336-06 22mm x 200mm

Sphincteroscopes
Sphincterosopes
Esfinteroscopios
Sphinctérosopes
Sfinteroscopi

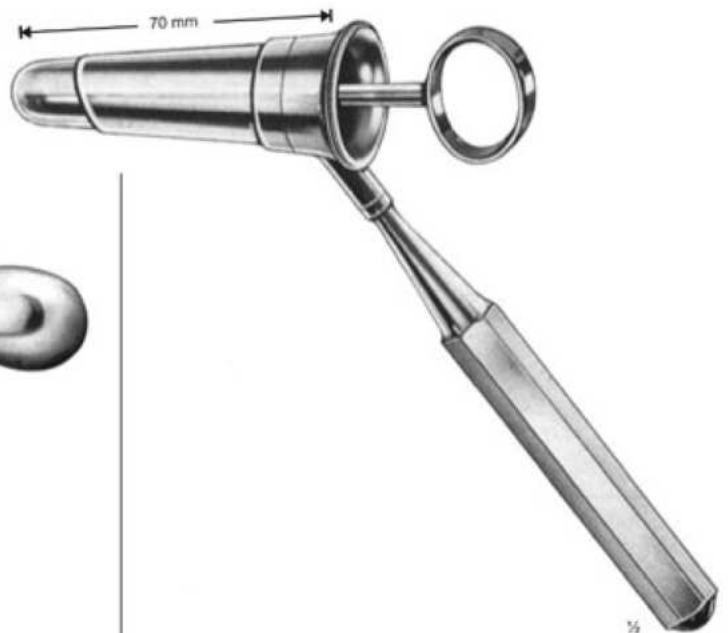

BENSAUDA

- 23-238-01 19 mm x 70 mm
- 23-238-02 19 mm x 70 mm



75 x 23 mm

SMITH-BUIE
23-340-15
15 cm, 6"



70 x 22 mm

BARR
23-342-17
17 cm, 6¾" c

23-350-03

23-350-02

23-350-01



ALAN-PARK
23-350-00
13,5 cm 5¼"

Set, Setz, Juego, Jeu, Serie

Rectal retractor with ball snap closure, complete, consisting of:

- 23-350-01 1 Spreader
- 23-350-02 1 Central valve 95 x 22 mm
- 23-350-03 1 Pair lateral valves 75 x 22 mm
- 23-350-04 1 Pair lateral valves 95 x 22 mm

Analspreizer mit Kugelschnellverschluss, komplett, bestehend aus:

- 23-350-01 1 Sperrer
- 23-350-02 1 Mittelvalve 95 x 22 mm
- 23-350-03 1 Paar Seitenvalven 75 x 22 mm
- 23-350-04 1 Paar Seitenvalven 95 x 22 mm

Separador para el recto con cierre esférico, completo, compuesto de:

- 23-350-01 1 Separador
- 23-350-02 1 Valva central 95 x 22 mm
- 23-350-03 1 Par de valvas laterales 75 x 22 mm
- 23-350-04 1 Par de valvas laterales 95 x 22 mm

Ecarteur rectal, complet, composé de:

- 23-350-01 1 Dilatateur
- 23-350-02 1 Valve centrale 95 x 22 mm
- 23-350-03 1 Paire de valves latérales 75 x 22 mm
- 23-350-04 1 Paire de valves latérales 95 x 22 mm

Dilatatore rettale con chiusura a scatto completo, composto da:

- 23-350-01 1 Dilatatore
- 23-350-02 1 Valve centrale 95 x 22 mm
- 23-350-03 1 Paia di valve laterali 75 x 22 mm
- 23-350-04 1 Paia di valve laterali 95 x 22 mm

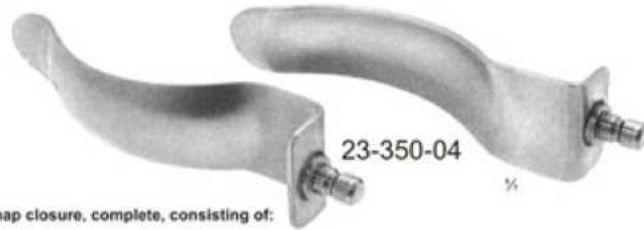

23-350-04

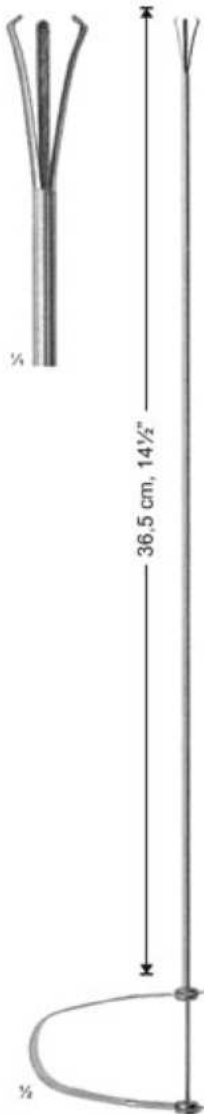

36,5 cm, 14½"

EDER
23-360-36
36,5 cm, 14½"

Cotton carrier
Watteträger
Porta-algodón
Porte-cotons
Portacotone

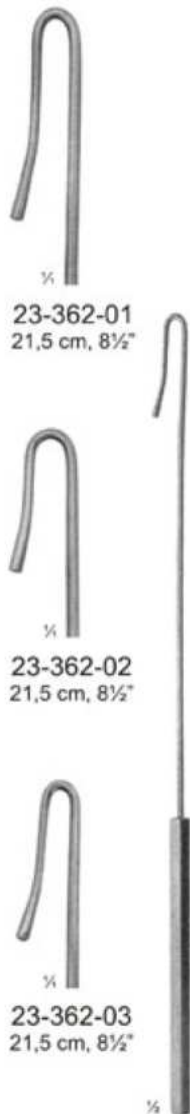

23-362-01
21,5 cm, 8½"

23-362-02
21,5 cm, 8½"

23-362-03
21,5 cm, 8½"

PRATT
23-362-01
23-362-03

Fistula probes (crypt hooks)
Fistelnsonden (Krypthaken)
Sondas para fistula (gancho para cripta)
Sondes pour fistules (crochets à crypte)
Sonde per fistola (gancio a cripta)



MC GIVNEY
23-365-19
19 cm, 7½"

Haemorrhoidal forceps
Hämorrhoiden-Faßzange
Pinza-clamp para hemorroides
Pinces-ciamps pour hémorroides
Pinze per emorroidi



BUIE
23-367-21
21 cm, 8¼"

Pressure clamp
Druckklemme
Pinza-clamp de presión progresiva
Pince-clamp à pression
Pinza/clamp a pressione



Haemorrhoidal ligator with loading attachment ø 12 mm
Hämorrhoiden-Ligatur mit Ladekonus ø 12 mm
Ligador para hemorroides con cono de carga ø 12 mm
Ligateur hémorroïdal avec cône de charge ø 12 mm
Legatori emorroidali con carica a cono ø 12 mm



RUDD
23-380-27
27,5 cm, 10¾"



FORD DIXON
23-386-00

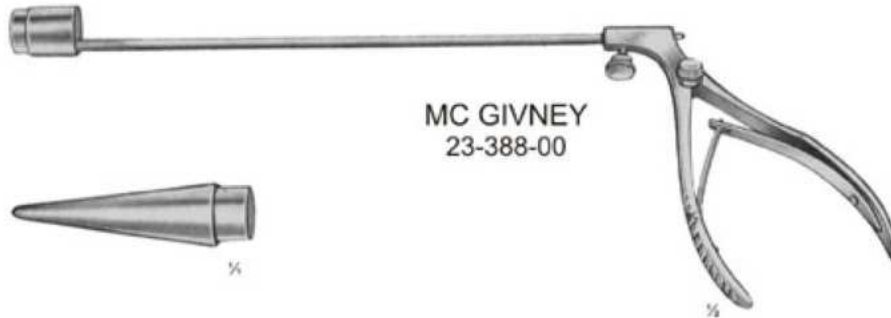
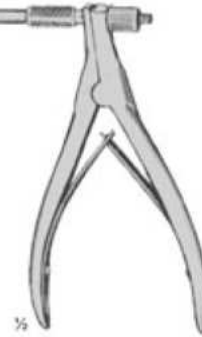

MC GIVNEY
23-388-00



Haemorrhoidal suctionligator with finger cut-off and loading cone
Hämorrhoiden-Saugligatur mit Unterbrecher und Ladekonus
Ligador de aspiración para hemorroides con interruptor y cono de carga
Ligateur aspirateur pour hémorroïdes avec interrupteur et cône d'aspiration
Legatore emorroidale con aspiratore, leva d'arresto e cono di carica



23-390-03
36,5 cm, 14½"



23-390-02
36,5 cm, 14½"

23-390-01
33,5 cm, 13¾"

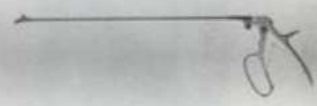

280 / 350 / 420 mm

23-400-28 23-400-35 23-400-42	23-402-28 23-402-35 23-402-42	23-404-28 23-404-35 23-404-42	23-406-28 23-406-35 23-406-42	YEOMAN 23-400-28 23-406-42

330 / 420mm

		23-410-33 23-410-42
		23-412-33 23-412-42
		23-414-33 23-414-42
		23-416-33 23-416-42
		23-418-33 23-418-42

YEOMAN TURRELL
23-410-33
23-418-42

380mm 15 1/4"

15 mm

23-430-38