

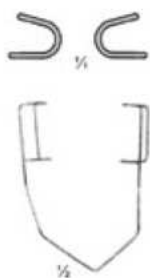

Self-Retaining Retractors, Abdominal Retractors
Wundspreizer (selbsthaltend), Bauchdeckenhalter
Separadores con retenida automática, Separadores abdominales
Ecarteurs autostatiques, Ecarteurs abdominaux
Divaricatori autostatici, Divaricatori addominali



BARRAQUER
 17-640-04
 4,5 cm, 1 3/4"



SAUER
 17-644-03
 3,5 cm, 1 1/4"



LANCASTER
 17-648-08
 8 cm, 3 1/8"



MELLINGER
 17-650-01
 17-650-03
 7 cm, 2 3/4"



17-650-01



17-650-02



17-650-03



17-671-05
 5 cm, 2"

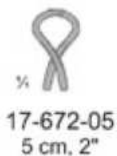

17-672-05
 5 cm, 2"



17-671-07
 7 cm, 2 3/4"



17-672-07
 7 cm, 2 3/4"

Sharp
 Spitz
 Agudo
 Pointu
 Acuto

Blunt
 Stumpf
 Romo
 Mousse
 Smusso



FINSEN
 17-671-05
 17-672-07



17-654-08
 8,5 cm, 3 1/4"

Self-retaining retractor
 Wundspreizer, selbsthaltend
 Separador con retenida automática
 Ecarteur autostatiques
 Divaricatori autostatici



17-654-11
 11,5 cm, 4 1/2"



17-656-04
 4,5 cm, 1 3/4"



17-658-05
 5,5 cm, 2"



MUELLER
 17-662-06
 6,5 cm, 2 1/2"

LOGAN
 17-666-04
 4,5 cm, 1 1/2"



FINSEN
 17-675-07 17-676-07
 7 cm, 2 3/4" 7 cm, 2 3/4"

Sharp
 Spitz
 Agudo
 Pointu
 Acuto

Blunt
 Stumpf
 Romo
 Mousse
 Smusso



17-681-07
 7 cm, 2 3/4"

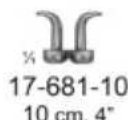

17-681-10
 10 cm, 4"

Sharp
 Spitz
 Agudo
 Pointu
 Acuto



ALM
 17-681-07
 17-682-10



17-682-07
 7 cm, 2 3/4"

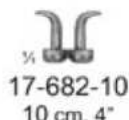

17-682-10
 10 cm, 4"

Blunt
 Stumpf
 Romo
 Mousse
 Smusso



17-687-10
 10 cm, 4"

Sharp
 Spitz
 Agudo
 Pointu
 Acuto

17-688-10
 10 cm, 4"

Blunt
 Stumpf
 Romo
 Mousse
 Smusso



VICKERS
17-710-04
4,5 cm, 1 3/4"

Finger retractor
Finger-Wundspreizer
Separador para dedos
Ecarteur pour doigts
Divaricatore per dita



VICKERS
17-702-09
9 cm, 3 1/2"

Hand and carpal tunnel retractor,
with central valve 18 x 10 mm (17-710-09)

Hand- und Carpal-Tunnel-Wundspreizer,
mit Mittelvalve 18x10 mm (17-710-09)

Separador de mano y túnel de carpo,
con valva central 18x10 mm (17-710-09)

Ecarteur pour mains et tunnel carpien,
avec valve médiane 18x10 mm (17-710-09)

Divaricatore per la mano con condotto carpale,
con valva centrale 18x10 mm (17-710-09)



VICKERS
17-704-10
10 cm, 4"

Deep hand and forearm retractor,
with central valve 18x10 mm (17-712-09)

Hand- und Unterarm-Wundspreizer,
mit Mittelvalve 18x10 mm (17-712-09)

Separador profundo para mano y antebrazo,
con valva central 18x10 mm (17-712-09)

Ecarteur profond pour main et avant bras,
avec valve médiane 18x10 mm (17-712-09)

Divaricatore per la mano e l'avambraccio,
con valva centrale 18x10 mm (17-712-09)



VICKERS
17-706-08
8 cm, 3 1/4"

Trigger finger and small wound retractor,
with central valve 18x10 mm (17-716-08)

Schnellender Finger- und kleiner Schnitt-Wund- spreizer,
mit Mittelvalve 18x10 mm (17-716-08)

Separador para dedos y pequeñas heridas,
con valva central 18x10 mm (17-716-08)

Ecarteur pour doigts et petites plaies,
avec valve médiane 18x10 mm (17-716-08)

Impugnatura a molla per dita e piccolo divaricatore per ferite,
con valva centrale 18x10 mm (17-716-08)

17-721-10
10 cm, 4"

Sharp
Spitz
Agudo
Pointu
Acuto



17-722-10
10 cm, 4"

Blunt
Stumpf
Romo
Mousse
Smusso

JANSEN
17-721-10
17-722-10



JANSEN
17-724-11
11 cm, 4 1/4"

Blunt
Stumpf
Romo
Mousse
Smusso

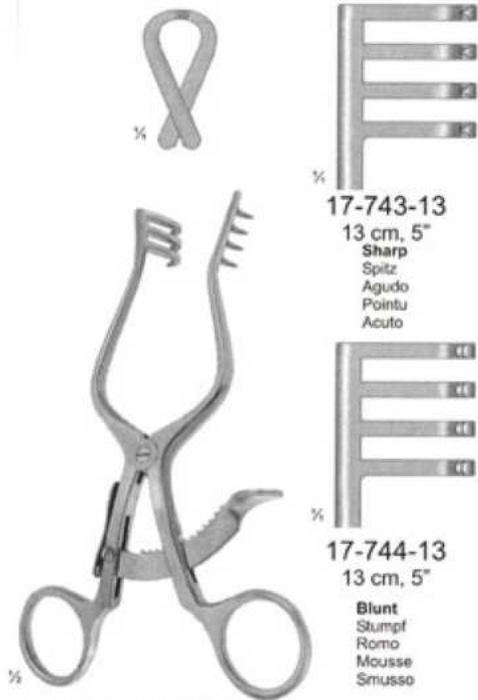

17-743-13
13 cm, 5"
Sharp
Spitz
Agudo
Pointu
Acuto

17-744-13
13 cm, 5"
Blunt
Stumpf
Romo
Mousse
Smusso

WULLSTEIN
17-743-13
17-744-13

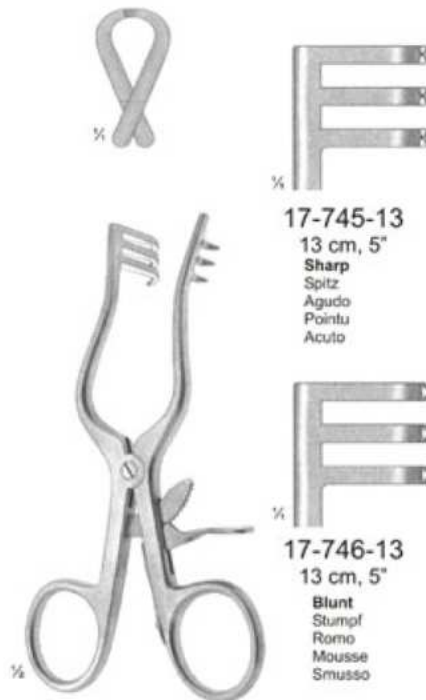

17-745-13
13 cm, 5"
Sharp
Spitz
Agudo
Pointu
Acuto

17-746-13
13 cm, 5"
Blunt
Stumpf
Romo
Mousse
Smusso

WETLANER-WULLSTEIN
17-745-13
17-746-13

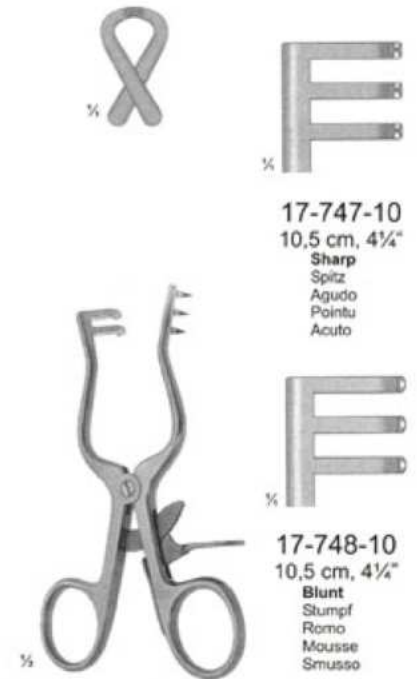

17-747-10
10,5 cm, 4 1/4"
Sharp
Spitz
Agudo
Pointu
Acuto

17-748-10
10,5 cm, 4 1/4"
Blunt
Stumpf
Romo
Mousse
Smusso

WEITLANER-LOKTITE
17-747-10
17-748-10

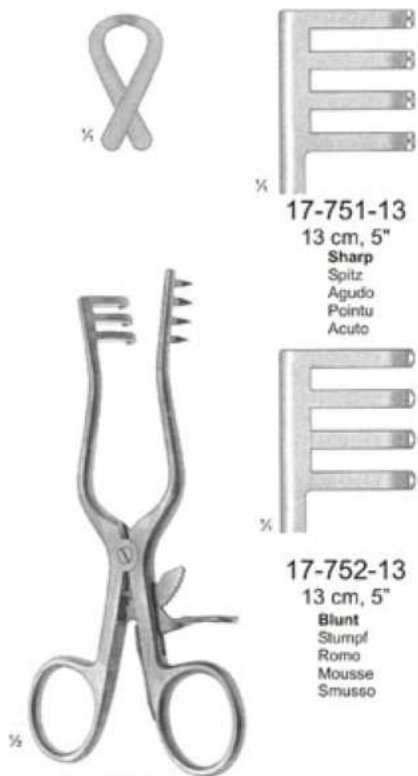

17-751-13
13 cm, 5"
Sharp
Spitz
Agudo
Pointu
Acuto

17-752-13
13 cm, 5"
Blunt
Stumpf
Romo
Mousse
Smusso

WEITLANER
17-751-13
17-752-13

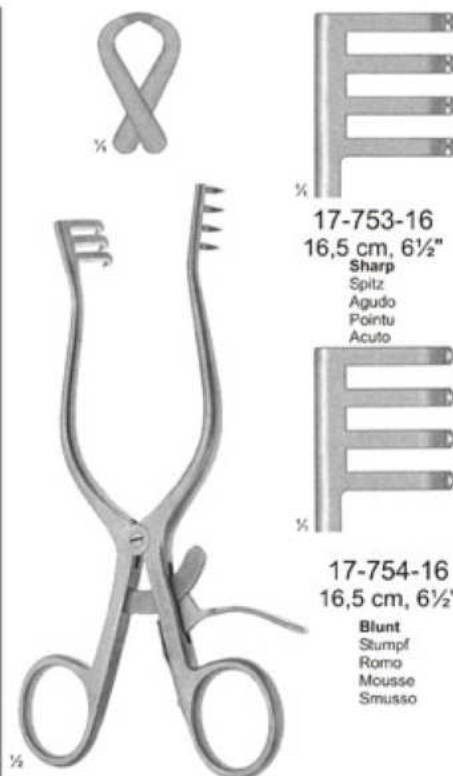

17-753-16
16,5 cm, 6 1/2"
Sharp
Spitz
Agudo
Pointu
Acuto

17-754-16
16,5 cm, 6 1/2"
Blunt
Stumpf
Romo
Mousse
Smusso

WEITLANER
17-753-16
17-754-16

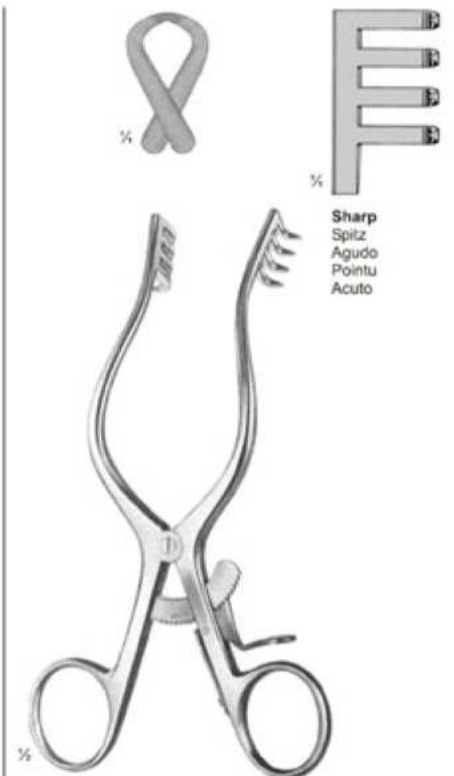

Sharp
Spitz
Agudo
Pointu
Acuto

MOLLISON
17-757-15
15 cm, 6"

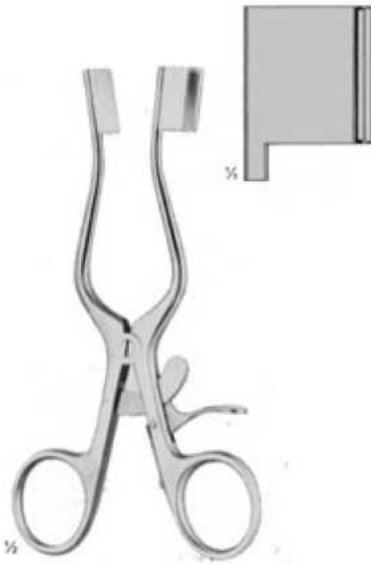

WEITLANER-BABY
17-770-13
13 cm, 5"

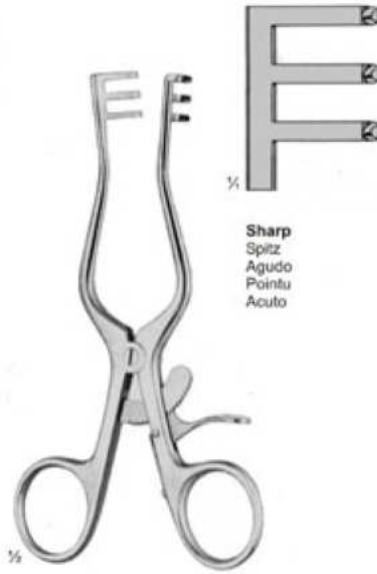

MILLIGAN
17-773-13
17-474-13
13 cm, 5"

Sharp
Spitz
Agudo
Pointu
Acuto

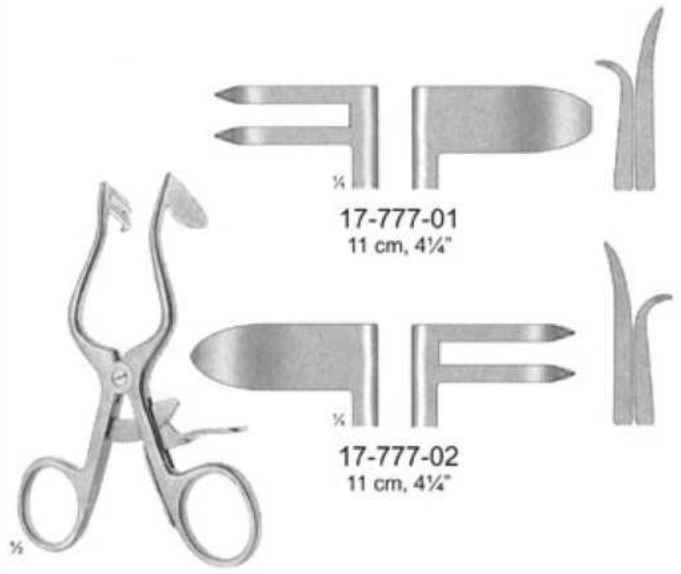

PLESTER
17-777-01
17-777-02

17-777-01
11 cm, 4 1/4"

17-777-02
11 cm, 4 1/4"

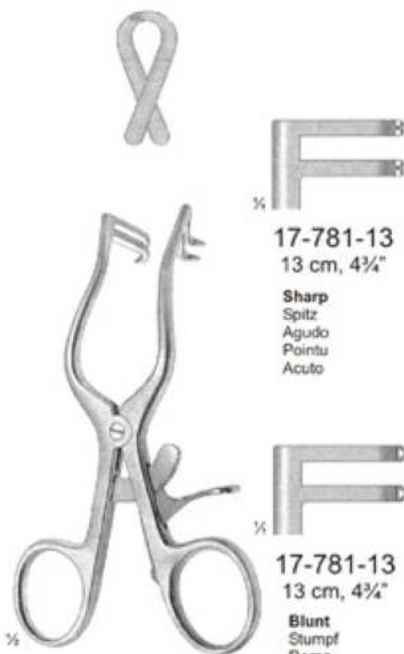

PLESTER
17-781-13
17-781-13
13 cm, 4 1/4"

17-781-13
13 cm, 4 1/4"

Sharp
Spitz
Agudo
Pointu
Acuto

17-781-13
13 cm, 4 1/4"

Blunt
Stumpf
Romo
Mousse
Smusso

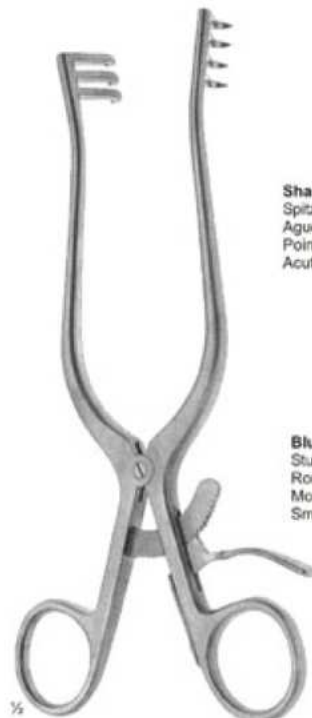

WEITLANER
17-785-01
17-786-03

Sharp
Spitz
Agudo
Pointu
Acuto

Blunt
Stumpf
Romo
Mousse
Smusso

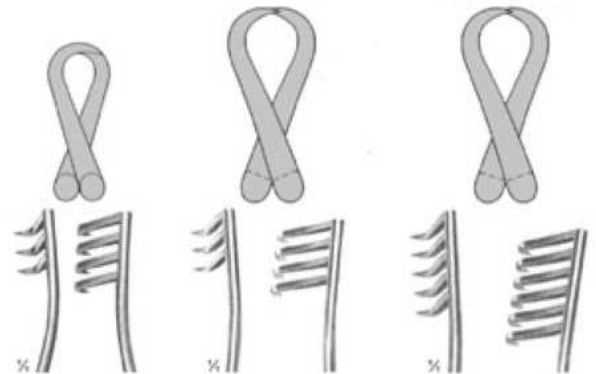

17-785-01
20 cm, 8"

17-785-02
24 cm, 9 1/4"

17-785-03
25,5 cm, 10"

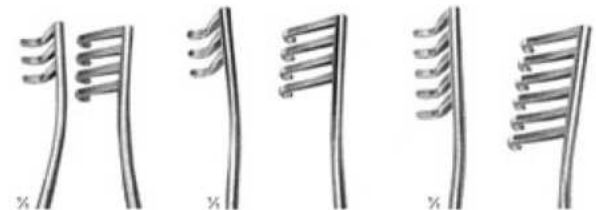

17-786-01
20 cm, 8"

17-786-02
24 cm, 9 1/4"

17-786-03
25,5 cm, 10"

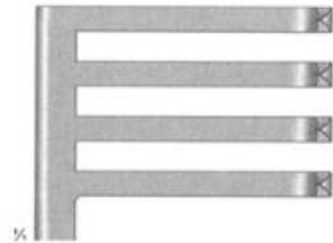

Sharp
Spitz
Agudo
Pointu
Acuto

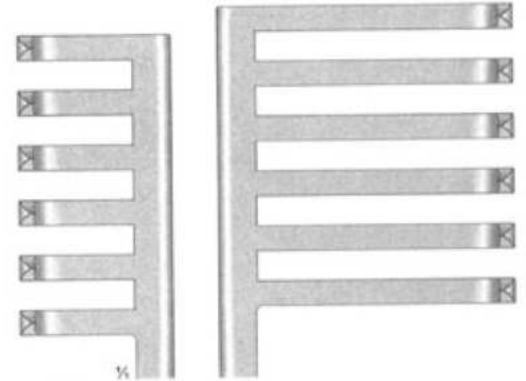

17-795-27

Sharp
Spitz
Agudo
Pointu
Acuto

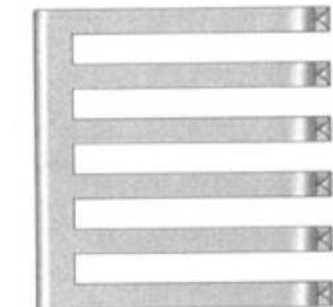

Blunt
Stumpf
Romo
Mousse
Smusso

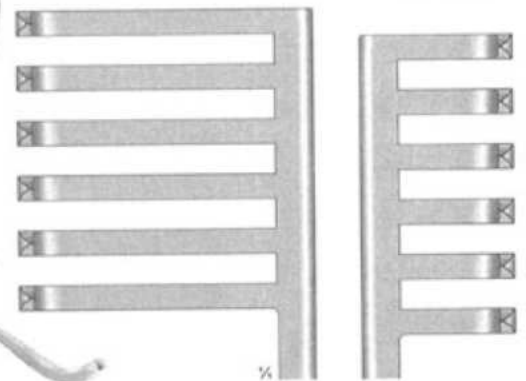

17-797-27

Blunt
Stumpf
Romo
Mousse
Smusso

ADSON
17-791-26
17-792-26
17-793-26
17-794-26
26,5 cm, 10½"

Laminectomy retractor
Laminektomie- Wundspreizer
Separador para laminectomia
Ecarteurs pour laminectomie
Divaricatori per laminectomia

ADSON
17-795-27
17-797-27
27 cm, 10½"

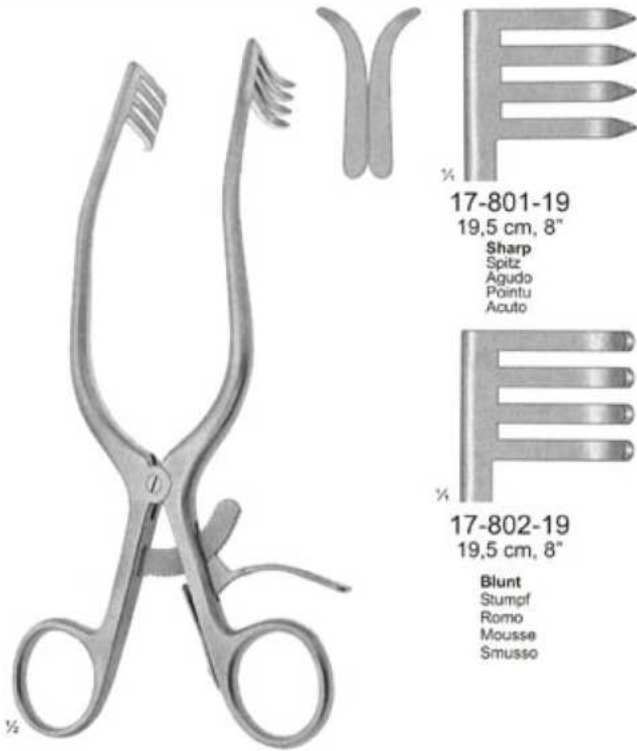

17-801-19
19,5 cm, 8"
Sharp
Spitz
Agudo
Pointu
Acuto

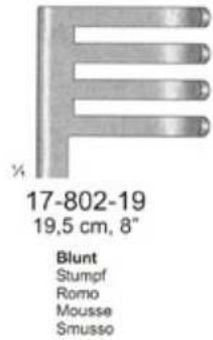

17-802-19
19,5 cm, 8"
Blunt
Stumpf
Romo
Mousse
Smusso

ANDERSON-ADSON
17-801-19
17-802-19

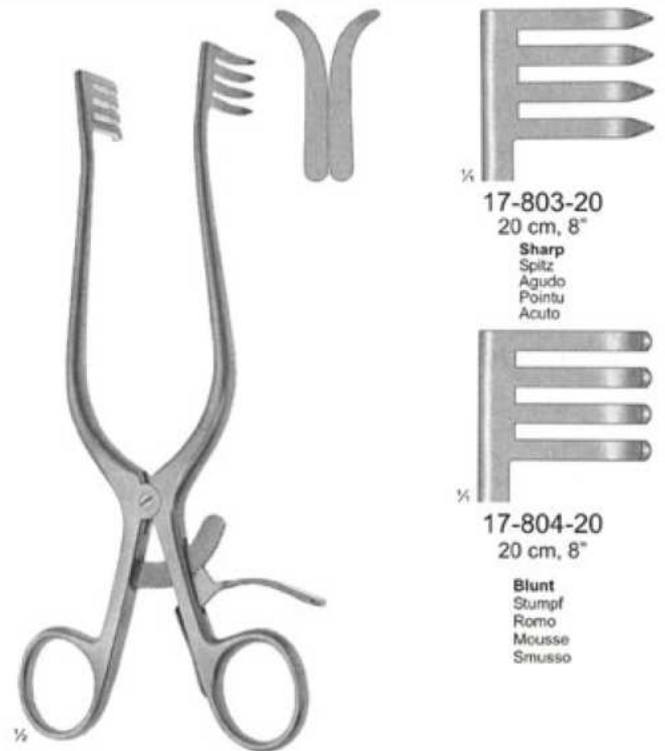

17-803-20
20 cm, 8"
Sharp
Spitz
Agudo
Pointu
Acuto

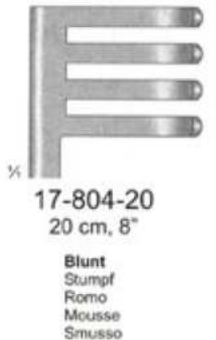

17-804-20
20 cm, 8"
Blunt
Stumpf
Romo
Mousse
Smusso

ADSON
17-803-20
17-804-20



Sharp
Spitz
Agudo
Pointu
Acuto

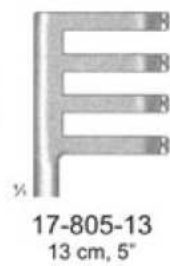

17-805-13
13 cm, 5"



17-805-16
16 cm, 6¼"

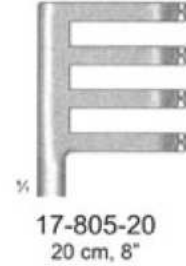

17-805-20
20 cm, 8"

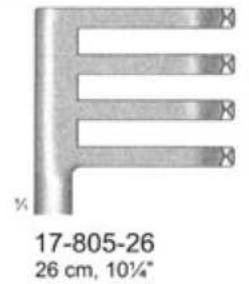

17-805-26
26 cm, 10¼"

Blunt
Stumpf
Romo
Mousse
Smusso

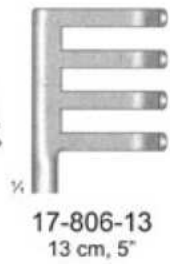

17-806-13
13 cm, 5"

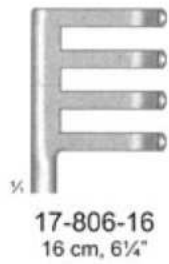

17-806-16
16 cm, 6¼"

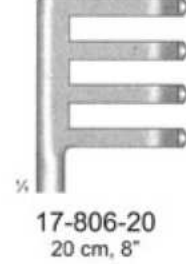

17-806-20
20 cm, 8"

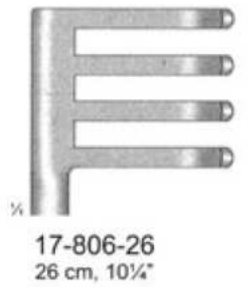

17-806-26
26 cm, 10¼"

ADSON
17-805-13
17-806-26



17-811-01
Sharp
Spitz
Agudo
Pointu
Acuto

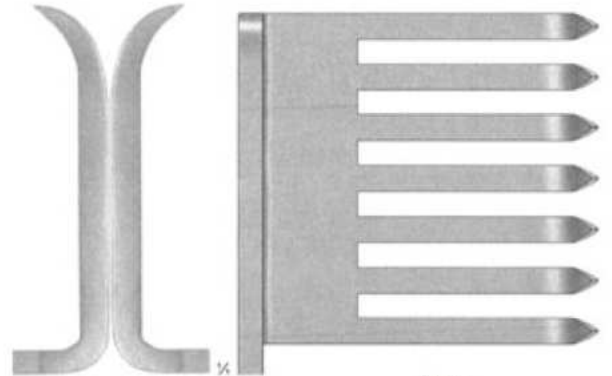

Sharp
Spitz
Agudo
Pointu
Acuto

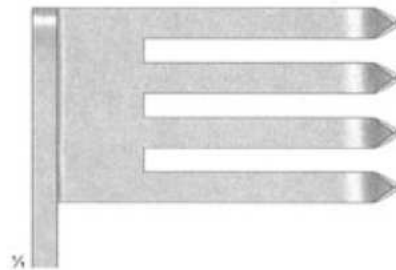

17-811-02
Sharp
Spitz
Agudo
Pointu
Acuto

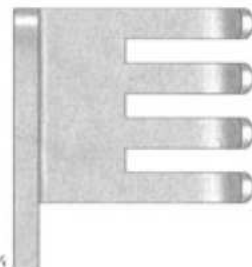

17-812-01
Blunt
Stumpf
Romo
Mousse
Smusso

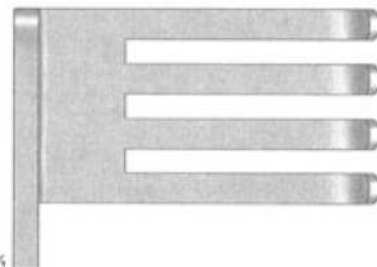

17-812-02
Blunt
Stumpf
Romo
Mousse
Smusso



BECKMANN-EATON
17-815-32
32 cm, 12 1/4"

BECKMANN-ADSON
17-811-01
17-811-02
31 cm, 12 1/4"

17-812-01
17-812-02
31 cm, 12 1/4"

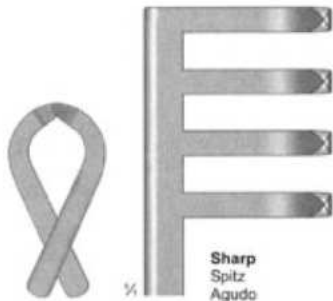

Sharp
Spitz
Agudo
Pointu
Acuto

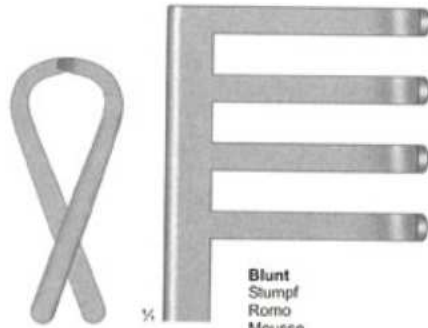

Blunt
Stumpf
Romo
Mousse
Smusso



BECKMANN
17-817-31
31 cm, 12¼"



ADSON
17-820-32
32 cm, 12½"

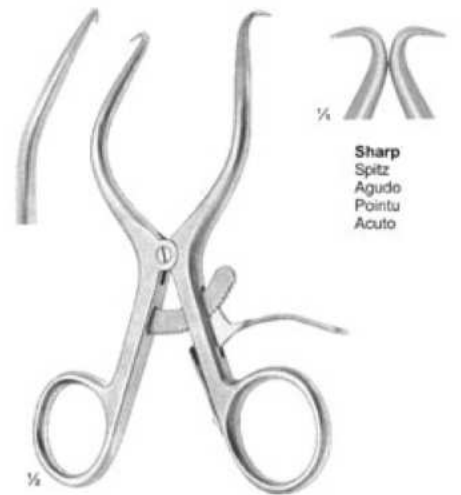

GELPI-LOKTILE
17-825-13
13 cm, 5"

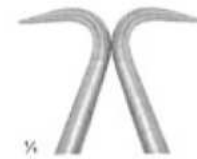

GELPI-LOKTIE
Sharp
Spitz
Agudo
Pointu
Acuto

Sharp
spitz
agudo
Pointu
Acuto

- 17-827-09
9 cm, 3½"
- 17-827-11
11 cm, 4½"
- 17-827-13
13 cm, 5"
- 17-827-18
18 cm, 7"



GELPI-SEIETZ
17-831-15
15 cm, 6"

Sharp
Spitz
Agudo
Pointu
Acuto



GELPI-LOKTITE
17-833-18
18 cm, 7"

Sharp
Spitz
Agudo
Pointu
Acuto



JOLL(FRIEDMAN)
17-837-15
15,5 cm, 6"

Sharp
Spitz
Agudo
Pointu
Acuto



MEYERDING
17-839-01
17-839-02
17-839-03
17-839-04
18 cm, 7"

Laminectomy retractors
Laminektomie-Wundspreizer
Separadores para laminectomia
Ecarteurs pour laminectomie
Divaricatori per laminectomia



17-841-01
40 x 15 - 40 mm



17-841-02
45 x 15 - 23 mm



17-841-03
50 x 15 - 23 mm



17-841-04
55 x 15 - 23 mm



17-841-05
60 x 15 - 23 mm



CLOWARD
17-841-01
17-841-05
25 cm, 10"

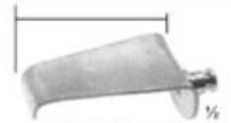

17-842-01
40 x 15 - 40 mm



17-842-02
45 x 15 - 23 mm



17-842-03
50 x 15 - 23 mm



17-842-04
55 x 15 - 23 mm



17-842-05
60 x 15 - 23 mm



CLOWARD
17-842-01
17-842-05
16 cm, 6 1/2"

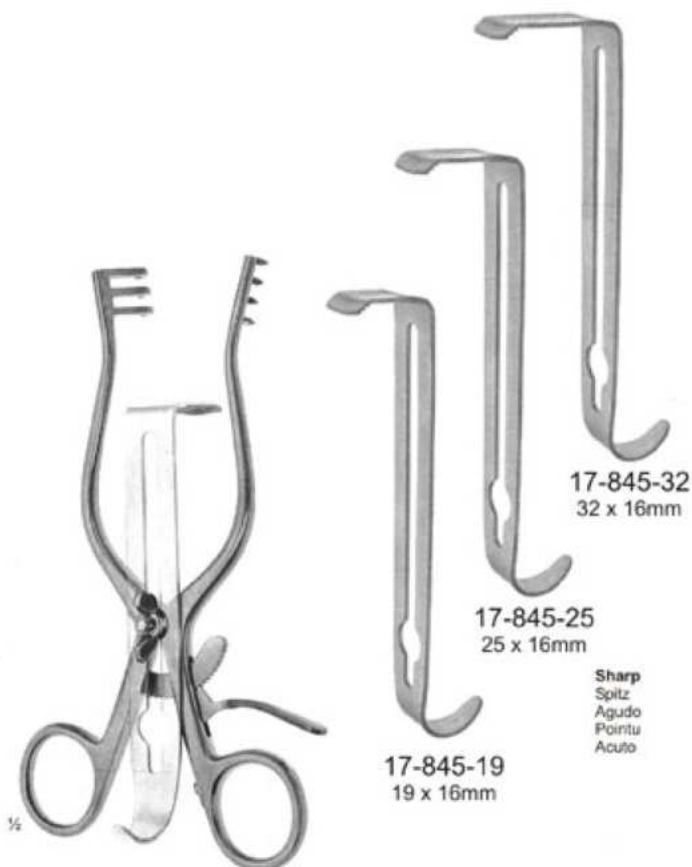

Sharp
Spitz
Agudo
Pointu
Acuto

HENLEY

17-845-16 17-845-19
16,5 cm, 6½" 17-845-32

Self-retaining retractor, complete, consisting of:
17-845-16 1 Spreader with lateral valves, sharp
17-845-19 1 Central valve, serrated, 19 x 16 mm
17-845-25 1 Central valve, serrated, 25 x 16 mm
17-845-32 1 Central valve, serrated, 32 x 16 mm

Wundspreizer, komplett, bestehend aus:
17-845-16 1 Sperrer mit Seitenvalven, spitz
17-845-19 1 Gezahnten Mittelvalve 19 x 16 mm
17-845-25 1 Gezahnten Mittelvalve 25 x 16 mm
17-845-32 1 Gezahnten Mittelvalve 32 x 16 mm

Separador, completo, compuesto de:
17-845-16 1 Separador con valve laterales agudas
17-845-19 1 Valva central, dentada, 19 x 16 mm
17-845-25 1 Valva central, dentada, 25 x 16 mm
17-845-32 1 Valva central, dentada, 32 x 16 mm

Ecarteur, complet, composé de:
17-845-16 1 Ecarteur avec valves laterales, griffes pointues
17-845-19 1 Valve central, dentelée 19 x 16 mm
17-845-25 1 Valve central, dentelée 25 x 16 mm
17-845-32 1 Valve central, dentelée 32 x 16 mm

Divaricatore, completo, composto da:
17-845-16 1 Divaricatore con valve laterali, acuto
17-845-19 1 Valva central, dentellata, 19 x 16 mm
17-845-25 1 Valva central, dentellata, 25 x 16 mm
17-845-32 1 Valva central, dentellata, 32 x 16 mm

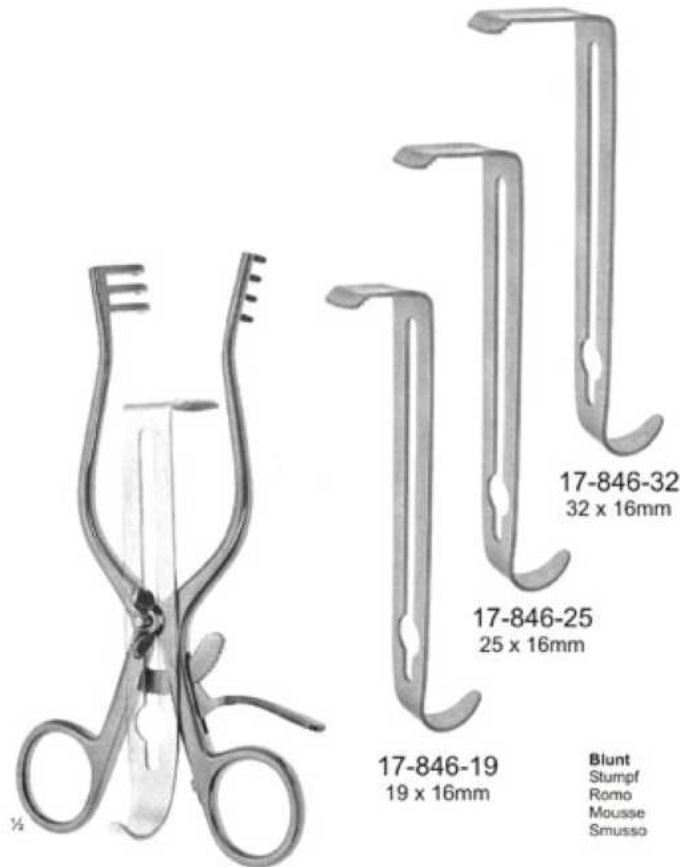

Blunt
Stumpf
Romo
Mousse
Smusso

HENLEY

17-846-16 17-846-19
16,5 cm, 6½" 17-846-32

Self-retaining retractor, complete, consisting of:
17-846-16 1 Spreader with lateral valves, blunt
17-846-19 1 Central valve, serrated, 19 x 16 mm
17-846-25 1 Central valve, serrated, 25 x 16 mm
17-846-32 1 Central valve, serrated, 32 x 16 mm

Wundspreizer, komplett, bestehend aus:
17-846-16 1 Sperrer mit Seitenvalven, stumpf
17-846-19 1 Gezahnten Mittelvalve 19 x 16 mm
17-846-25 1 Gezahnten Mittelvalve 25 x 16 mm
17-846-32 1 Gezahnten Mittelvalve 32 x 16 mm

Separador, completo, compuesto de:
17-846-16 1 Separador con valve laterales romas
17-846-19 1 Valva central, dentada, 19 x 16 mm
17-846-25 1 Valva central, dentada, 25 x 16 mm
17-846-32 1 Valva central, dentada, 32 x 16 mm

Ecarteur, complet, composé de:
17-846-01 1 Ecarteur avec valves laterales, griffes mouses
17-846-02 1 Valve central, dentelée 19 x 16 mm
17-846-03 1 Valve central, dentelée 25 x 16 mm
17-846-04 1 Valve central, dentelée 32 x 16 mm

Divaricatore, completo, composto da:
17-846-01 1 Divaricatore con valve laterali, smusso
17-846-02 1 Valva central, dentellata, 19 x 16 mm
17-846-03 1 Valva central, dentellata, 25 x 16 mm
17-846-04 1 Valva central, dentellata, 32 x 16 mm

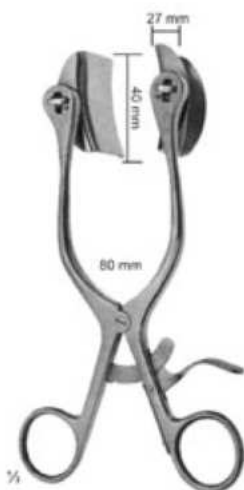

BABY-COLLIN
17-850-18
18 cm, 7"

Abdominal retractor, complete, consisting of:
17-850-01 1 Spreader
17-850-02 1 Pair lateral valves 18 x 40 mm
17-850-03 1 Pair lateral valves 27 x 40 mm

Bauchdeckenhalter, komplett, bestehend aus:
17-850-01 1 Sperrer
17-850-02 1 Paar Seitenvälven 18 x 40 mm
17-850-03 1 Paar Seitenvälven 27 x 40 mm

Separador abdominal, completo, compuesto de:
17-850-01 1 Separador
17-850-02 1 Par de valvas laterales 18 x 40 mm
17-850-03 1 Par de valvas laterales 27 x 40 mm

Ecarteur abdominal, complet, composé de:
17-850-01 1 Ecarteur
17-850-02 1 Paire de valves latérales 18 x 40 mm
17-850-03 1 Paire de valves latérales 27 x 40 mm

Divaricatore addominale, completo, composto da:
17-850-01 1 Divaricatore
17-850-02 1 Paio di valve laterali 18 x 40 mm
17-850-03 1 Paio di valve laterali 27 x 40 mm

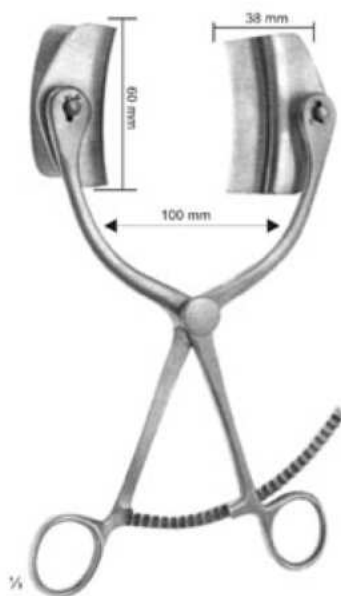

COLLIN
17-856-23
23 cm, 9"

Abdominal retractor, complete consisting of:
17-856-01 1 Spreader
17-856-02 1 Pair lateral valves 38 x 60 mm

Bauchdeckenhalter, komplett, bestehend aus:
17-856-01 1 Sperrer
17-856-02 1 Paar Seitenvälven 38 x 60 mm

Separador abdominal, completo, compuesto de:
17-856-01 1 Separador
17-856-02 1 Par de valvas laterales 38 x 60 mm

Ecarteur abdominal, complet, composé de:
17-856-01 1 Ecarteur
17-856-02 1 Paire de valves latérales 38 x 60 mm

Divaricatore addominale, completo, composto da:
17-856-01 1 Divaricatore
17-856-02 1 Paio di valve laterali 38 x 60 mm

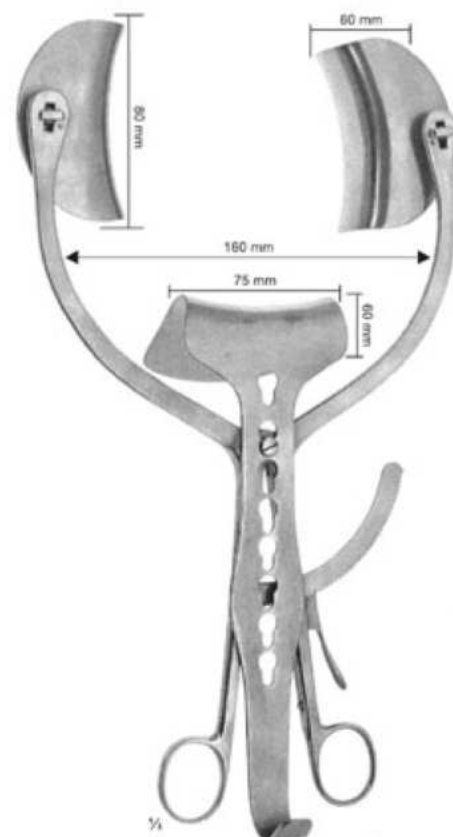

COLLIN-LOKTITE
17-859-26
26 cm, 10½"

Abdominal retractor, complete consisting of:
17-859-01 1 Spreader
17-859-02 1 Pair lateral valves 60 x 80 mm
17-859-03 1 Mittelvalve 60 x 75 mm

Bauchdeckenhalter, komplett, bestehend aus:
17-859-01 1 Sperrer
17-859-02 1 Paar Seitenvälven 60 x 80 mm
17-859-03 1 Central valve 60 x 75 mm

Separador abdominal, completo, compuesto de:
17-859-01 1 Separador
17-859-02 1 Par de valvas laterales 60 x 80 mm
17-859-03 1 Valva central 60 x 75 mm

Ecarteur abdominal, complet, composé de:
17-859-01 1 Ecarteur
17-859-02 1 Paire de valves latérales 60 x 80 mm
17-859-03 1 Valva centrale 60 x 75 mm

Divaricatore addominale, completo, composto da:
17-859-01 1 Divaricatore
17-859-02 1 Paio di valve laterali 60 x 80 mm
17-859-03 1 Valva centrale 60 x 75 mm

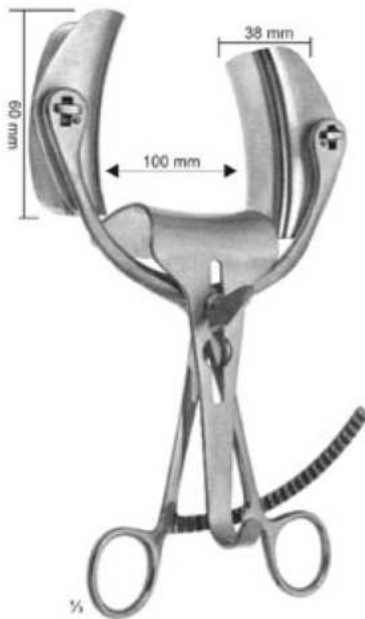

COLLIN
 17-860-25
 25 cm, 9½"

Abdominal retractor, complete, consisting of:
 17-860-01 1 Spreader
 17-860-02 1 Pair lateral valves 38 x 80 mm
 17-860-03 1 Pair lateral valves 55 x 55 mm

Bauchdeckenhalter, komplett, bestehend aus:
 17-860-01 1 Sperrer
 17-860-02 1 Paar Seitenvalven 38 x 80 mm
 17-860-03 1 Paar Seitenvalven 55 x 55 mm

Separador abdominal, completo, compuesto de:
 17-860-01 1 Separador
 17-860-02 1 Par de valvas laterales 38 x 80 mm
 17-860-03 1 Par de valvas laterales 55 x 55 mm

Ecarteur abdominal, complet, composé de:
 17-860-01 1 Ecarteur
 17-860-02 1 Paire de valves latérales 38 x 80 mm
 17-860-03 1 Paire de valves latérales 55 x 55 mm

Divaricatore addominale, completo, composto da:
 17-860-01 1 Divaricatore
 17-860-02 1 Paio di valve laterali 38 x 80 mm
 17-860-03 1 Paio di valve laterali 55 x 55 mm



COLLIN
 17-862-26
 26 cm, 10¼"

Abdominal retractor, complete, consisting of:
 17-862-01 1 Spreader
 17-862-02 1 Pair lateral valves 40 x 100 mm
 17-862-03 1 Pair lateral valves 55 x 75 mm

Bauchdeckenhalter, komplett, bestehend aus:
 17-862-01 1 Sperrer
 17-862-02 1 Paar Seitenvalven 40 x 100 mm
 17-862-03 1 Paar Seitenvalven 55 x 75 mm

Separador abdominal, completo, compuesto de:
 17-862-01 1 Separador
 17-862-02 1 Par de valvas laterales 40 x 100 mm
 17-862-03 1 Par de valvas laterales 55 x 75 mm

Ecarteur abdominal, complet, composé de:
 17-862-01 1 Ecarteur
 17-862-02 1 Paire de valves latérales 40 x 100 mm
 17-862-03 1 Paire de valves latérales 55 x 75 mm

Divaricatore addominale, completo, composto da:
 17-862-01 1 Divaricatore
 17-862-02 1 Paio di valve laterali 40 x 100 mm
 17-862-03 1 Paio di valve laterali 55 x 75 mm



RICARD
 17-870-28
 28 cm, 11"
 17-870-30
 30 cm, 12"

Abdominal retractor, complete consisting of:
 17-870-01 1 Spreader
 17-870-02 1 Pair lateral valves 60 x 80 mm
 17-870-03 1 Mittelvalve 55 x 70 mm

Bauchdeckenhalter, komplett, bestehend aus:
 17-870-01 1 Sperrer
 17-870-02 1 Paar Seitenvalven 60 x 80 mm
 17-870-03 1 Central valve 55 x 70 mm

Separador abdominal, completo, compuesto de:
 17-870-01 1 Separador
 17-870-02 1 Par de valvas laterales 60 x 80 mm
 17-870-03 1 Valva central 55 x 70 mm

Ecarteur abdominal, complet, composé de:
 17-870-01 1 Ecarteur
 17-870-02 1 Paire de valves latérales 60 x 80 mm
 17-870-03 1 Valva centraie 55 x 70 mm

Divaricatore addominale, completo, composto de:
 17-870-01 1 Divaricatore
 17-870-02 1 Paio di valve laterali 60 x 80 mm
 17-870-03 1 Valva centraie 55 x 70 mm

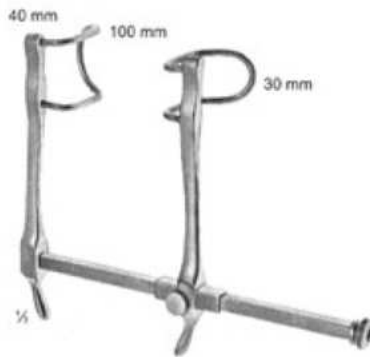

GOSSET-BABY
17-880-00



GOSSET
17-884-00
Set, Setz, Juego, Jeu, Serie



GOSSET
17-882-00



BALFOUR-BABY
17-890-00
Set, Setz, Juego, Jeu, Serie



BALFOUR
17-892-00 180mm
17-892-01 200mm
Set, Setz, Juego, Jeu, Serie



BALFOUR
17-894-00 180mm
17-894-01 200mm
Set, Setz, Juego, Jeu, Serie



BALFOUR
17-896-00 180mm
17-896-01 200mm
Set, Setz, Juego, Jeu, Serie

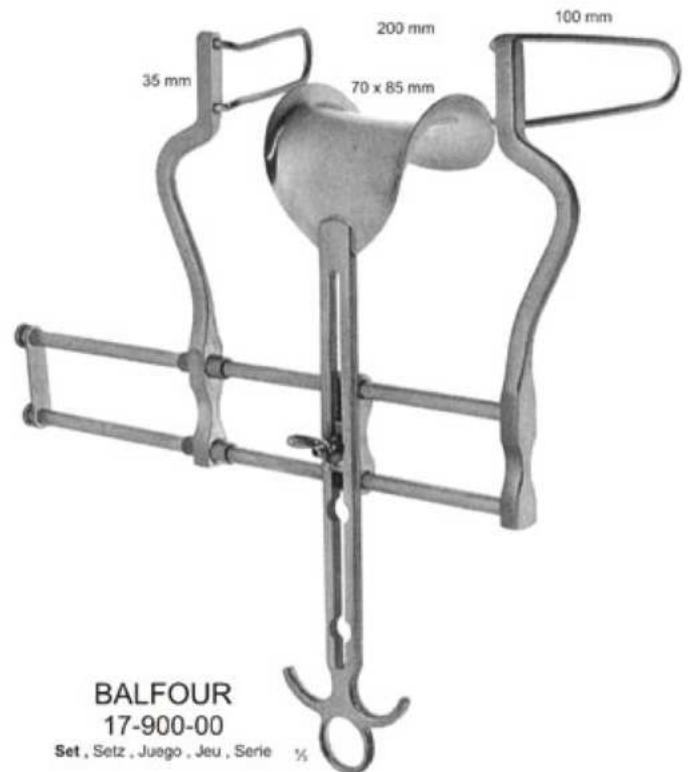

BALFOUR
17-900-00
Set, Setz, Juego, Jeu, Serie



BALFOUR
17-910-00 250mm
17-910-01 300mm
Set , Setz , Juego , Jeu , Serie

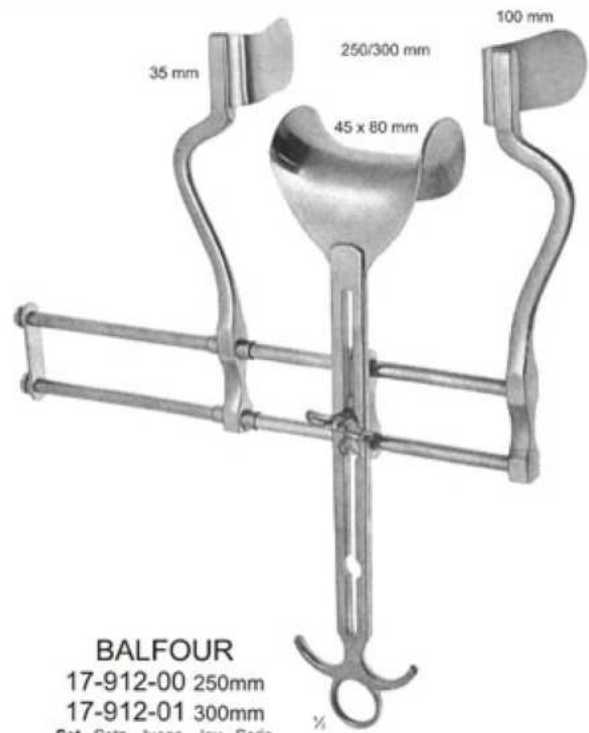

BALFOUR
17-912-00 250mm
17-912-01 300mm
Set , Setz , Juego , Jeu , Serie



BALFOUR-US TYPE
17-914-00



Central valves, for abdominal retractors
Mittelvalven für Bauchdeckenhalter
Valvas centrales, para separadores abdominales
Valvas cintrales, pour écarteurs abdominaux
Valve centrali, per divaricatori addominali

BALFOUR
17-920-01 45 x 80 mm
17-920-02 70 x 85 mm
17-920-03 45 x 90 mm



ROCHARD
17-930-01

Mounting frame for fastening to both sides of the lateral bare 25 x 10 mm of the operating tables, can be dismantled for sterilization

Befestigungsgestell mit beidseitiger Fixierung an den seitenschienen 25 x 10 mm der OP-Tische, zur Sterilisation zerigbar

Bastidor para la fijación a las ambas barras laterales 25 x 10 mm de las mesas de operación, plegable para la esterilización

Cadre se fixant aux barres latérales 25 x 10 mm de chaques côtés de la table d'opération, pliable pour stérilisation

Telaio di supporto per il fissaggio alla barre laterali 25 x 10 mm del tavolo operatorio può essere smontato per la sterilizzazione



ROCHARD
17-938-19
19,5 cm, 7 3/4"

Fixation device for 17-966-01_17-966-05
Fixiervorrichtung für 17-966-01_17-966-05
Dispositivo de fijación para 17-966-01_17-966-05
Compas articulé pour 17-966-01_17-966-05
Dispositivo di fissaggio per 17-966-01_17-966-05



ROCHARD
17-930-02

Mounting frame for fastening to the lateral bare 25 x 10 mm of the operating tables, can be dismantled for sterilization

Befestigungsgestell mit beidseitiger Fixierung an den seitenschienen 25 x 10 mm der OP-Tische, zur Sterilisation zeriegbar

Bastidor para la fijación a las ambas laterales 25 x 10 mm de las mesas de operación, plegable para la esterilización

Cadre se fixant aux barres latérales 25 x 10 mm de chaques côtés de la table d'opération, pliable pour stérilisation

Telaio di per il fissaggio alla barra laterali 25 x 10 mm del tavolo operatorio può essere smontato per la sterilizzazione



ROCHARD
17-936-01 50 x 90 mm
17-936-02 50 x 105 mm
17-936-03 50 x 120 mm
17-936-04 50 x 135 mm
17-936-05 50 x 155 mm
29 cm, 11 1/2"

Abdominal retractors
Bauchdeckenhaken
Separadores abdominales
Ecarteur abdominal
Divaricatore addominale



O'SULLIVAN-O'CONNOR
 17-950-00

Abdominal rtractor, complete, consisting of:
 17-950-01 1 Frame
 17-950-02 2 Valves 80 x 45 mm
 17-950-03 1 Valve 110 x 70 mm

Bauchdeckenhalter, komplett, bestehend aus:
 17-950-01 1 Rahmen
 17-950-02 2 Valven 80 x 45 mm
 17-950-03 1 Valve 110 x 70 mm

Separador abdominal, completo, compuesto de:
 17-950-01 1 Cuadro
 17-950-02 2 Valvas 80 x 45 mm
 17-950-03 1 Valva 110 x 70 mm

Ecarteur abdominal, complet, composé de:
 17-950-01 1 Cadre
 17-950-02 2 Valves 80 x 45 mm
 17-950-03 1 Valve 110 x 70 mm

Divaricatore addominale, completo, compsto da:
 17-950-01 1 Telaio
 17-950-02 2 Valve 80 x 45 mm
 17-950-03 1 Valva 110 x 70 mm

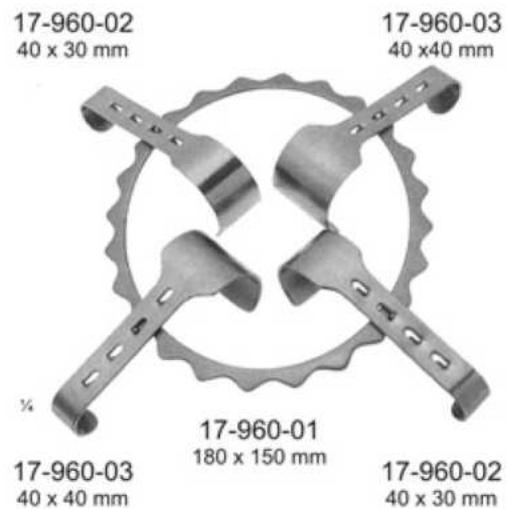

DENIS-BROWNE

17-960-00 180 x 150 mm
 17-960-01 255 x 180 mm

Abdominal rtractor, complete, consisting of:
 17-960-01 1 Frame 180 x 150 mm
 17-960-02 2 Valves 40 x 30 mm
 17-960-03 2 Valves 40 x 40 mm

Bauchdeckenhalter, komplett, bestehend aus:
 17-960-01 1 Rahmen 180 x 150 mm
 17-960-02 2 Valven 40 x 30 mm
 17-960-03 2 Valven 40 x 40 mm

Separador abdominal, completo, compuesto de:
 17-960-01 1 Cuadro 180 x 150 mm
 17-960-02 2 Valvas 40 x 30 mm
 17-960-03 2 Valvas 40 x 40 mm

Ecarteur abdominal, complet, composé de:
 17-960-01 1 Cadre 180 x 150 mm
 17-960-02 2 Valves 40 x 30 mm
 17-960-03 2 Valvas 40 x 40 mm

Divaricatore addominale, completo, composto da:
 17-960-01 1 Telaio 180 x 150 mm
 17-960-02 2 Valve 40 x 30 mm
 17-960-03 2 Valve 40 x 40 mm

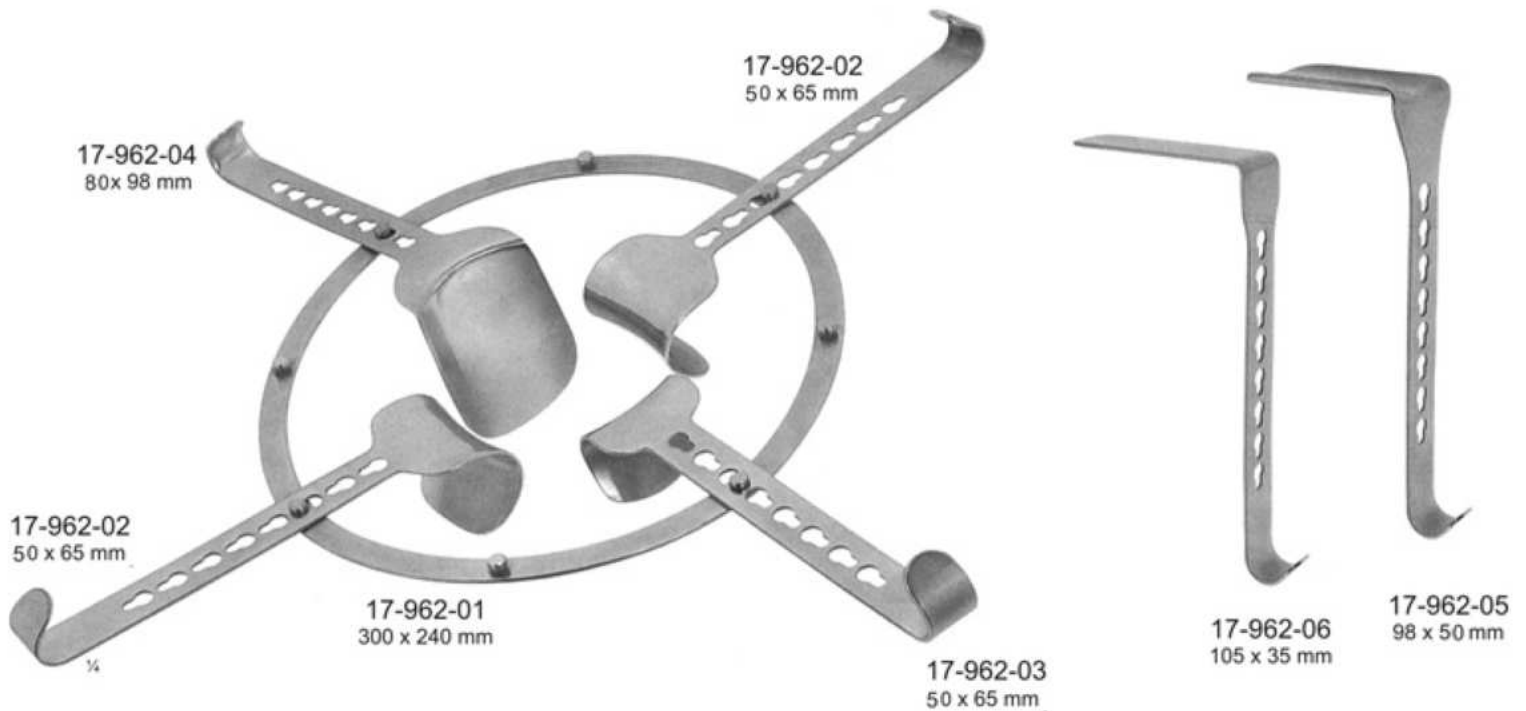

SEMM
17-962-00

Set , Setz , Juego , Jeu , Serie

Abdominal retractor, complete, consisting of:
17-962-01 1 Frame 300 x 240 mm
17-962-02 3 Valves 50 x 65 mm
17-962-04 1 Valve for intestine 76 x 98 mm
17-962-05 1 Valve for intestine 98 x 52 mm
17-962-06 1 Valve 105 x 35 mm

Bauchdeckenhalter, komplett, bestehend aus:
17-962-01 1 Rahmen 275 x 240 mm
17-962-02 3 Valven 50 x 65 mm
17-962-04 1 Valve für den Darm 76 x 98 mm
17-962-05 1 Valve für den Darm 98 x 52 mm
17-962-06 1 Valve 105 x 35 mm

Separador abdominal, completo, compuesto de:
17-962-01 1 Cuadro 275 x 240 mm
17-962-02 3 Valvas 50 x 65 mm
17-962-04 1 Valva para intestino 76 x 98 mm
17-962-05 1 Valva para intestino 98 x 52 mm
17-962-06 1 Valva 105 x 35 mm

Ecarteur abdominal, complet, composé de:
17-962-01 1 Cadre 275 x 250 mm
17-962-02 3 Valves 50 x 65 mm
17-962-04 1 Valve pour intestin 76 x 98 mm
17-962-05 1 Valve pour intestin 98 x 52 mm
17-962-06 1 Valve 105 x 35 mm

Divaricatore addominale, completo, composto da:
17-962-01 1 Telaio 300 x 240 mm
17-962-02 3 Valve 50 x 65 mm
17-962-04 1 Valva per intestino 76 x 98 mm
17-962-05 1 Valva per intestino 98 x 52 mm
17-962-06 1 Valva 105 x 35 mm

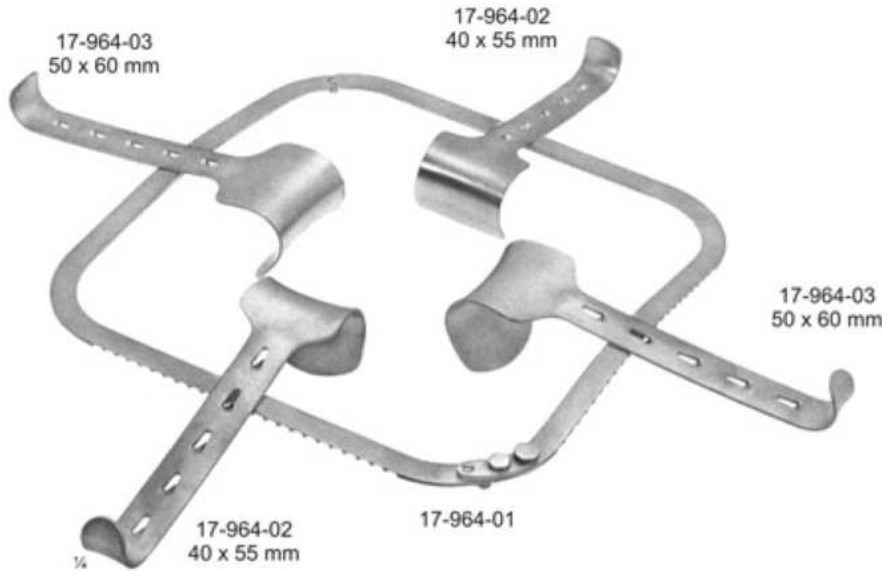

KIRSCHNER
17-964-00

Set , Setz , Juego , Jeu , Serie

Abdominal Retractor, complete, consisting of:
17-964-01 1 Folding frame 255 x 255 mm
17-964-02 2 Valves 40 x 55 mm
17-964-03 2 Valves 50 x 60 mm

Bauchdeckenhalter, komplett, bestehend aus:
17-964-01 1 zusammenlegbarer Rahmen 255 x 255 mm
17-964-02 2 Valven 40 x 55 mm
17-964-03 2 Valven 50 x 60 mm

Separador abdominal, completo, compuesto de:
17-964-01 1 Cuadro plegable 255 x 255 mm
17-964-02 2 Valvas 40 x 55 mm
17-964-03 2 Valvas 50 x 60 mm

Ecarteur abdominal, complet, composé de:
17-964-01 1 Cadre pliant 255 x 255 mm
17-964-02 2 Valves 40 x 55 mm
17-964-03 2 Valves 50 x 60 mm

Divaricatore addominale, completo, composto da:
17-964-01 1 Telaio pieghevole 255 x 255 mm
17-964-02 2 Valve 40 x 55 mm
17-964-03 2 Valve 50 x 60 mm

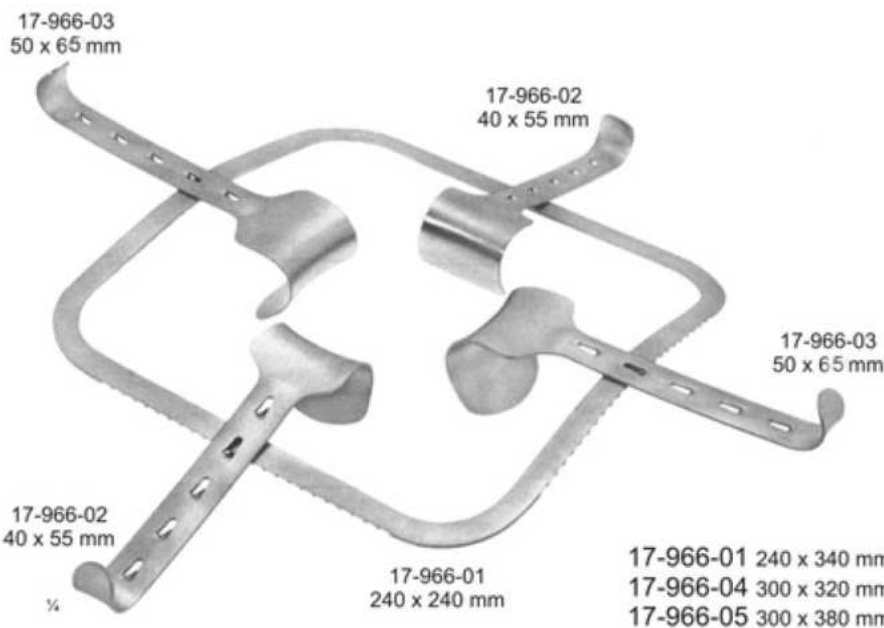

KIRSCHNER
17-966-02

Set , Setz , Juego , Jeu , Serie

Abdominal Retractor, complete, consisting of:
17-966-01 1 Fixed frame 240 x 240 mm
17-966-02 2 Valves 40 x 55 mm
17-966-03 2 Valves 50 x 60 mm

Bauchdeckenhalter, komplett, bestehend aus:
17-966-01 1 starrer Rahmen 240 x 240 mm
17-966-02 2 Valven 40 x 55 mm
17-966-03 2 Valven 50 x 60 mm

Separador abdominal, completo, compuesto de:
17-966-01 1 Cuadro fijo 240 x 240 mm
17-966-02 2 Valvas 40 x 55 mm
17-966-03 2 Valvas 50 x 65 mm

Ecarteur abdominal, complet, composé de:
17-966-01 1 Cadre fixe 240 x 240 mm
17-966-02 2 Valve 40 x 55 mm
17-966-03 2 Valve 50 x 65 mm

Divaricatore addominale, completo, composto da:
17-966-01 1 Telaio pieghevole 240 x 240 mm
17-966-02 2 Valve 40 x 55 mm
17-966-03 2 Valve 50 x 65 mm

Fixed frames
Starre Rahmen
Cuadros fijos
Cadres fixe
Telaio fisso



KIRSCHNER

17-970-01 40x55mm
17-970-02 50x65mm
17-970-03 60x85mm
17-970-04 78x65mm
17-970-05 80x90mm

¼



**KIRSCHNER
BALFOUR**

17-972-01
17-972-02
78x65mm
80x90mm

¼



STANDARD

17-974-01
17-974-02
17-974-03
40x55mm
50x65mm
60x85mm

¼



KIRSCHNER

17-976-01
17-976-02
98x50mm
105x35mm

¼

Laminectomy Retractors
Laminektomie-Spreizer
Separadores para laminectomia
Ecarteurs pour laminectomie
Divaricatori per laminectomia

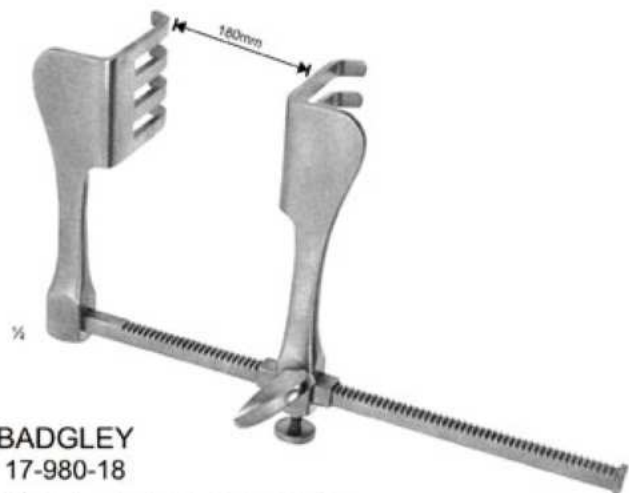

BADGLEY
17-980-18

Self-retaining retractor, lateral velvies 52 x 22 mm
Wundspreizer, Seitenvalvaen 52 x 22 mm
Separador, valvas laterales 52 x 22 mm
Ecarteur, valves laterales 52 x 22 mm
Divaricatore, valve laterali 52 x 22 mm



Self-retaining retractor, complete, consisting of:
17-982-01 1 Frame
17-982-01 1 Hook 50mm
17-982-03 1 Lateral valve 64 x 25 mm

Wundspreizer, komplett, bestehend aus:
17-982-01 1 Rahmen
17-982-01 1 Haken 50 mm
17-982-03 1 Seitenvaive 64 x 25 mm

Separador, completo, compuesto de:
17-982-01 1 Cuadro
17-982-01 1 Gancho 50 mm
17-982-03 1 Valva lateral 64 x 25 mm

Ecarteur, complet, composé de:
17-982-01 1 Cadre
17-982-01 1 Crochet 50 mm
17-982-03 1 Valve latérale 64 x 25 mm

Divaricatore, completo, composto da:
17-982-01 1 Telaio
17-982-01 1 Divaricatore 50 mm
17-982-03 1 Valva laterale 64 x 25 mm

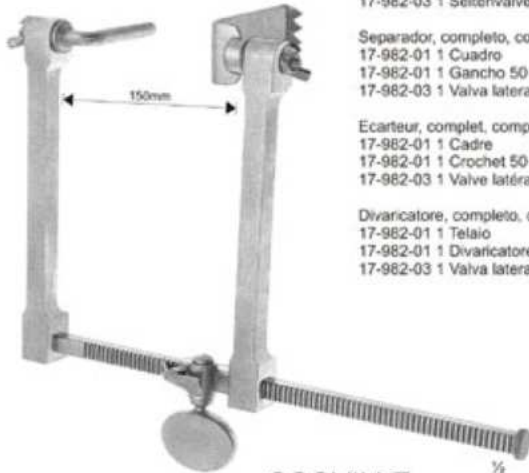

SCOVILLE
17-982-00



SCOVILLE
17-982-01 50 mm
17-982-02 70 mm

Hooks for self-retaining retractors 17-982-00 and 17-984-00

Haken für Wundspreizer
17-982-00 und 17-984-00

Ganchos para separadores
17-982-00 y 17-984-00

Crochet pour écarteurs
17-982-00 et 17-984-00

Gancio per divaricatori
17-982-00 e 17-984-00



SCOVILLE
17-982-03 64 X 25 mm
17-982-04 64 X 50 mm
17-982-05 88 X 25 mm

Lateral valves for self-retaining retractors 17-982-00 and 17-984-00

Seitenvaiven für Wundspreizer
17-982-00 und 17-984-00

Valvas laterales para separadores
17-982-00 y 17-984-00

Valves latérales pour écarteurs
17-982-00 et 17-984-00

Valve laterali per divaricatori
17-982-00 e 17-984-00

With articulated arms
Mit Gelenkarmen
Cón brazos articulados
Avec bras, articulés
Con braccio articolato

Self-retaining retractor, complete, consisting of:
17-984-01 1 Frame
17-982-01 1 Hook 50mm
17-982-03 1 Lateral valve 64 x 25 mm

Wundspreizer, komplett, bestehend aus:
17-984-01 1 Rahmen
17-982-01 1 Haken 50 mm
17-982-03 1 Seitenvaive 64 x 25 mm

Separador, completo, compuesto de:
17-984-01 1 Cuadro
17-982-01 1 Gancho 50 mm
17-982-03 1 Valva lateral 64 x 25 mm

Ecarteur, complet, composé de:
17-984-01 1 Cadre
17-982-01 1 Crochet 50mm
17-982-03 1 Valve latérale 64 x 25 mm

Divaricatore, completo, composto da:
17-984-01 1 Telaio
17-982-01 1 Divaricatore 50 mm
17-982-03 1 Valva laterale 64 x 25 mm

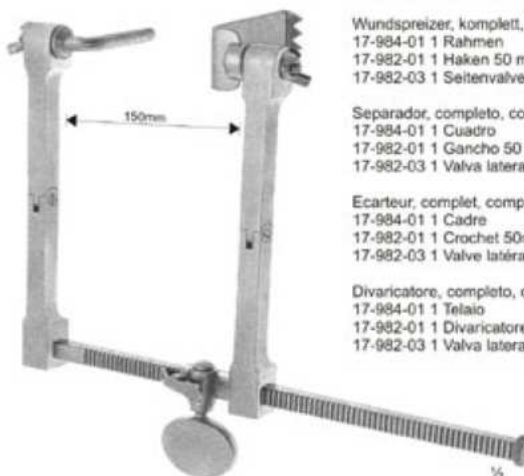

SCOVILLE-HAVERFIELD
17-984-00



SCOVILLE
17-982-06 41 X 38 mm
17-982-07 67 X 44 mm

Lateral valves for self-retaining retractors 17-982-12 and 17-984-00

Seitenvaiven für Wundspreizer
17-982-12 und 17-984-00

Valvas laterales para separadores
17-982-12 y 17-984-00

Valves latérales pour écarteurs
17-982-12 et 17-984-00

Valve laterali per divaricatori
17-982-12 e 17-984-00



TAYLOR
17-982-08 48 X 50 mm
17-982-09 64 X 50 mm
17-982-10 64 X 64 mm
17-982-11 80 X 57 mm

Lateral valves for self-retaining retractors 17-982-00 and 17-984-00

Seitenvaiven für Wundspreizer
17-982-00 und 17-984-00

Valvas laterales para separadores
17-982-00 y 17-984-00

Valves latérales pour écarteurs
17-982-00 et 17-984-00

Valve laterali per divaricatori
17-982-00 e 17-984-00