

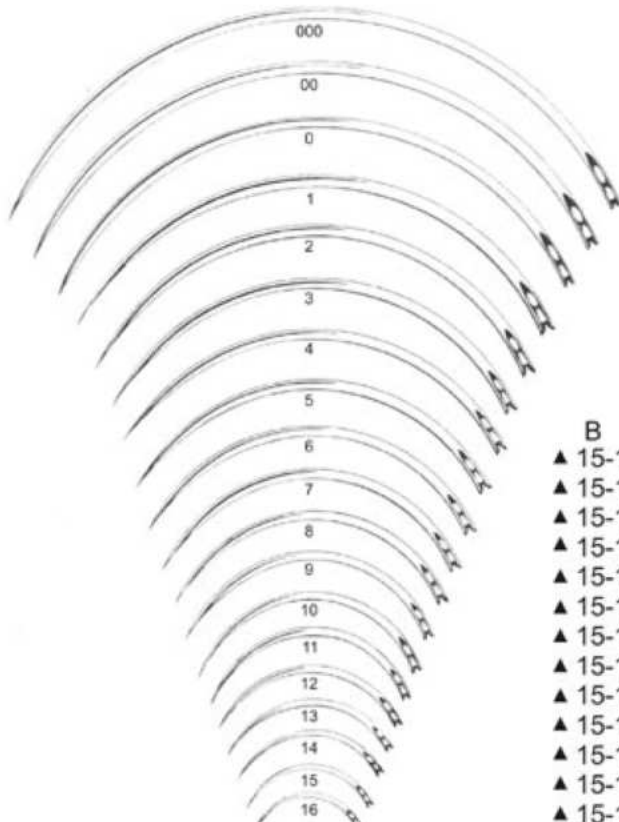

Suture Instruments
Nahtinstrumente
Instrumentos para sutura
Instrumenti à suture
Strumenti per sutura

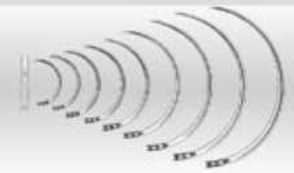

▲ $\frac{1}{2}$
15-111-01
15-113-16

Curved $\frac{1}{2}$ circle, in packages of 12 pieces
Gebogen $\frac{1}{2}$ kreis, in packungen zu 12 stück
Curvas $\frac{1}{2}$ círculo, cajecita de 12 piezas
Courbure $\frac{1}{2}$ cercle, paquet de 12
Curvi $\frac{1}{2}$ di cerchio, in confezione da 12 pz.

B		G	
▲ 15-111-01	000	▲ 15-121-01	000
▲ 15-111-02	00	▲ 15-121-02	00
▲ 15-111-03	0	▲ 15-121-03	0
▲ 15-113-01	1	▲ 15-123-01	1
▲ 15-113-02	2	▲ 15-123-02	2
▲ 15-113-03	3	▲ 15-123-03	3
▲ 15-113-04	4	▲ 15-123-04	4
▲ 15-113-05	5	▲ 15-123-05	5
▲ 15-113-06	6	▲ 15-123-06	6
▲ 15-113-07	7	▲ 15-123-07	7
▲ 15-113-08	8	▲ 15-123-08	8
▲ 15-113-09	9	▲ 15-123-09	9
▲ 15-113-10	10	▲ 15-123-10	10
▲ 15-113-11	11	▲ 15-123-11	11
▲ 15-113-12	12	▲ 15-123-12	12
▲ 15-113-13	13	▲ 15-123-13	13
▲ 15-113-14	14	▲ 15-123-14	14
▲ 15-113-15	15	▲ 15-123-15	15
▲ 15-113-16	16	▲ 15-123-16	16

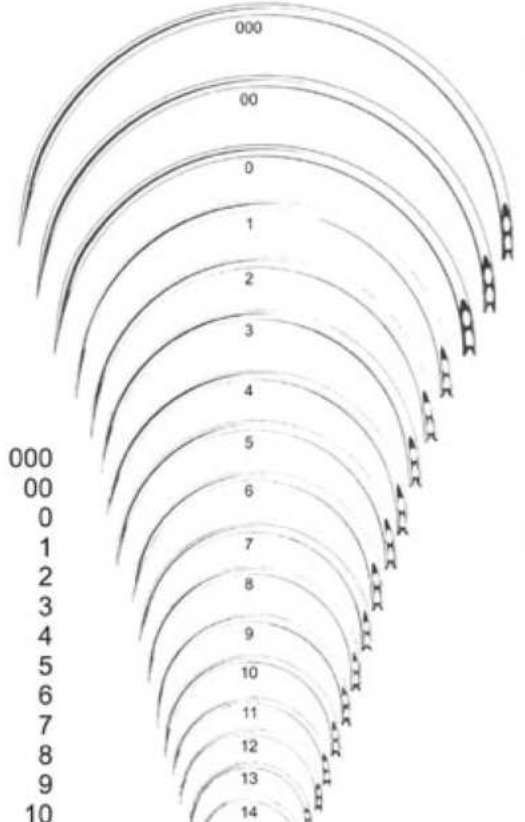

▲ $\frac{1}{2}$
15-121-01
15-123-16

Curved $\frac{1}{2}$ circle, in packages of 12 pieces
Gebogen $\frac{1}{2}$ kreis, in packungen zu 12 stück
Curvas $\frac{1}{2}$ círculo, cajecita de 12 piezas
Courbure $\frac{1}{2}$ cercle, paquet de 12
Curvi $\frac{1}{2}$ di cerchio, in confezione da 12 pz.

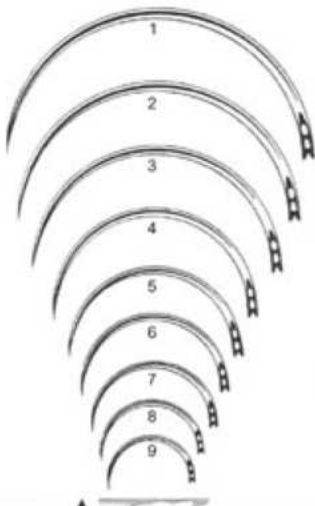

▲ $\frac{1}{2}$
15-131-01
15-131-09

Curved $\frac{1}{2}$ circle, in packages of 12 pieces
Gebogen $\frac{1}{2}$ kreis, in packungen zu 12 stück
Curvas $\frac{1}{2}$ círculo, cajecita de 12 piezas
Courbure $\frac{1}{2}$ cercle, paquet de 12
Curvi $\frac{1}{2}$ di cerchio, in confezione da 12 pz.

Ga	
▲ 1	15-131-01
▲ 2	15-131-02
▲ 3	15-131-03
▲ 4	15-131-04
▲ 5	15-131-05
▲ 6	15-131-06
▲ 7	15-131-07
▲ 8	15-131-08
▲ 9	15-131-09

E	
● 000	15-141-01
● 00	15-141-02
● 0	15-141-03
● 1	15-143-01
● 2	15-143-02
● 3	15-143-03
● 4	15-143-04
● 5	15-143-05
● 6	15-143-06

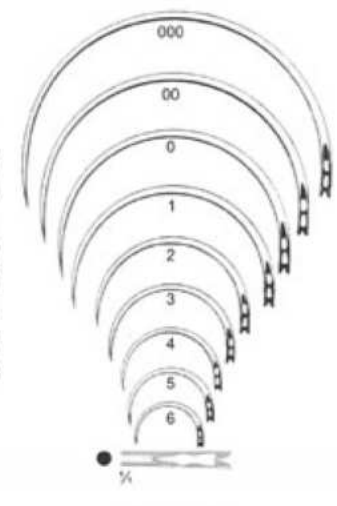

● $\frac{1}{2}$
15-141-01
15-143-06

Curved $\frac{1}{2}$ circle, in packages of 12 pieces
Gebogen $\frac{1}{2}$ kreis, in packungen zu 12 stück
Curvas $\frac{1}{2}$ círculo, cajecita de 12 piezas
Courbure $\frac{1}{2}$ cercle, paquet de 12
Curvi $\frac{1}{2}$ di cerchio, in confezione da 12 pz.

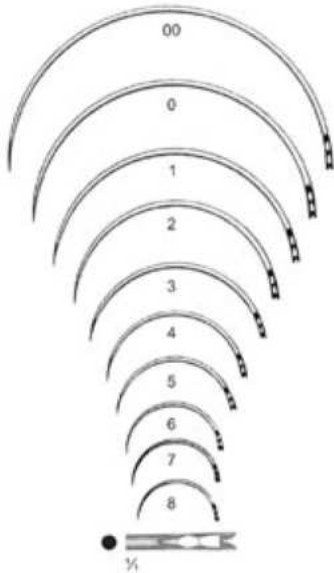
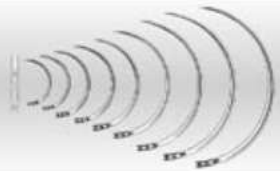

15-161-01
15-163-08

- Pb**
- 00 15-161-01
 - 0 15-161-02
 - 1 15-163-01
 - 2 15-163-02
 - 3 15-163-03
 - 4 15-163-04
 - 5 15-163-05
 - 6 15-163-06
 - 7 15-163-07
 - 8 15-163-08

Intestinal needles, curved $\frac{1}{4}$ circle, in packages of 12 pieces

Darmnadeln, gebogen $\frac{1}{4}$ kreis, packungen zu 12 Stück

Agujas para suturas intestinales, curvas $\frac{1}{4}$ círculo, cajecita de 12 piezas

Aiguilles intestinales, $\frac{1}{4}$ de cercle, paquet de 12.

Aghi per sutura intestinale curvi $\frac{1}{4}$ di cerchio, in confezione da 12 pz.

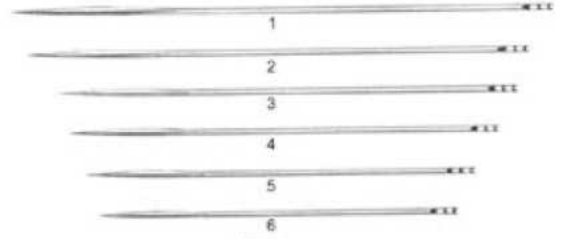

KEITH

- ▲ 1 15-180-01
 - ▲ 2 15-180-02
 - ▲ 3 15-180-03
 - ▲ 4 15-180-04
 - ▲ 5 15-180-05
 - ▲ 6 15-180-06
- 15-180-01
15-180-06

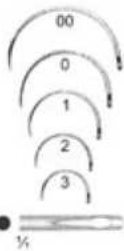

PAYR

- 00 15-201-01
- 0 15-201-02
- 1 15-203-01
- 2 15-203-02
- 3 15-203-03

15-201-01
15-203-03

Vascular suture needles, curved $\frac{1}{4}$ circle, in packages of 12 pieces

Gefäßnadeln, gebogen $\frac{1}{4}$ Kreis, in Packungen zu 12 Stück

Agujas vasculares, curvas $\frac{1}{4}$ círculo, cajecita de 12 piezas

Aiguilles vasculaires, $\frac{1}{4}$ de cercle, paquet de 12

Aghi per sutura vascolare curvi $\frac{1}{4}$ di cerchio, in confezione da 12 pz.

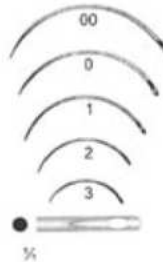

KALT

- 00 15-211-01
- 0 15-211-02
- 1 15-213-01
- 2 15-213-02
- 3 15-213-03

15-211-01
15-213-03

Vascular suture needles, curved $\frac{1}{4}$ circle, in packages of 12 pieces

Gefäßnadeln, gebogen $\frac{1}{4}$ Kreis, in Packungen zu 12 Stück

Agujas vasculares, curvas $\frac{1}{4}$ círculo, cajecita de 12 piezas

Aiguilles vasculaires, $\frac{1}{4}$ de cercle, paquet de 12

Aghi per sutura vascolare curvi $\frac{1}{4}$ di cerchio, in confezione da 12 pz.



Og

- ▲ 0 15-221-01
 - ▲ 1 15-223-01
 - ▲ 2 15-223-02
 - ▲ 3 15-223-03
 - ▲ 4 15-223-04
 - ▲ 5 15-223-05
- 15-221-01
15-223-05

Eye needles, curved $\frac{1}{4}$ circle, in packages of 12 pieces

Augennadeln, gebogen $\frac{1}{4}$ kreis, in packungen zu 12 Stück

Agujas para suturas oculares, curvas $\frac{1}{4}$ círculo, cajecita de 12 piezas

Aiguilles pour ophtalmologie, $\frac{1}{4}$ de cercle, paquet de 12 piezas

Aghi per oftalmologia, curvi $\frac{1}{4}$ di cerchio, in confezione da 12 pz.

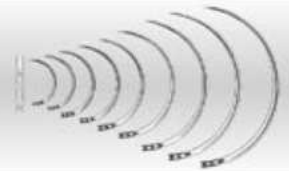

15-250-01 62 x 13 mm
Interior box only
Innendose allein
Caja interior, suelta
Boîte intérieure seule
Scatola interiore sola

15-250-00 65 x 15 mm
Exterior and interior box
Außen- und Innendose
Caja exterior e interior
Boîte extérieure et intérieure
Scatola esterna ed interiore



15-256-01 50 x 25 x 4,5 mm
15-256-02 65 x 42 x 8,0 mm
15-256-03 77 x 25 x 4,5 mm



15-260-01
150 x 95 x 13 mm



SAUERBRUCH
15-264-01
210 x 125 x 17 mm



SAUERBRUCH
15-264-02
210 x 125 x 17 mm

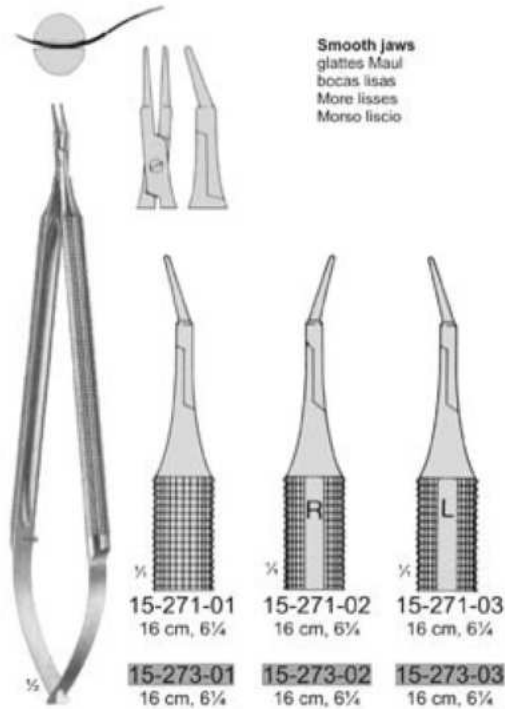

Smooth jaws
glattes Maul
bocas lisas
More lisées
Morso liscio

15-271-01 16 cm, 6 1/4"
15-271-02 16 cm, 6 1/4"
15-271-03 16 cm, 6 1/4"
15-273-01 16 cm, 6 1/4"
15-273-02 16 cm, 6 1/4"
15-273-03 16 cm, 6 1/4"

GOMEL
15-271-01
15-271-03

GOMEL
15-273-01
15-273-03

Titanium



Smooth jaws
glattes Maul
bocas lisas
More lisées
Morso liscio

15-275-01 14 cm, 5 1/2"
15-275-02 14 cm, 5 1/2"
15-275-03 14 cm, 5 1/2"
15-277-01 14 cm, 5 1/2"
15-277-02 14 cm, 5 1/2"
15-277-03 14 cm, 5 1/2"

GOMEL
15-275-01
15-275-03

GOMEL
15-277-01
15-277-03

Titanium

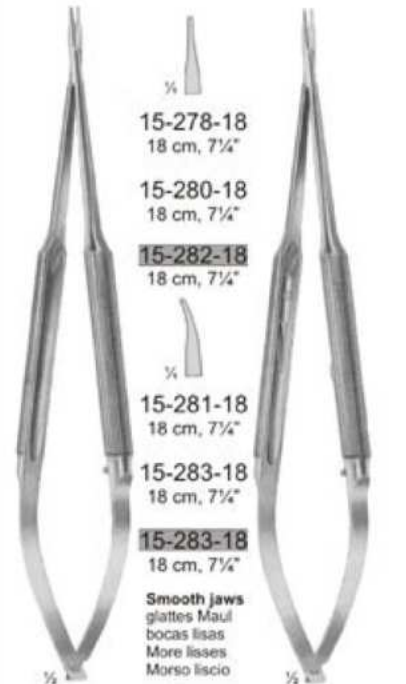

15-278-18 18 cm, 7 1/4"

15-280-18 18 cm, 7 1/4"

15-282-18 18 cm, 7 1/4"

15-281-18 18 cm, 7 1/4"

15-283-18 18 cm, 7 1/4"

15-283-18 18 cm, 7 1/4"

Smooth jaws
glattes Maul
bocas lisas
More lisées
Morso liscio

15-278-18
15-281-18

15-282-18
15-283-18

15-288-18
15-283-18

Titanium

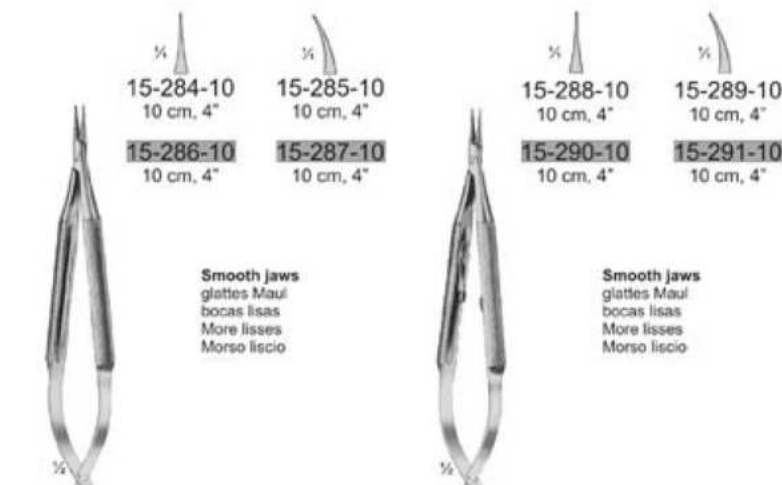

Smooth jaws
glattes Maul
bocas lisas
More lisées
Morso liscio

Smooth jaws
glattes Maul
bocas lisas
More lisées
Morso liscio

BARRAQUER
TROUTMAN
15-284-10
15-287-10

BARRAQUER
TROUTMAN
15-288-10
15-291-10

Titanium

Titanium



Smooth jaws
glattes Maul
bocas lisas
More lisées
Morso liscio

BARRAQUER
15-293-11
15-295-13

Titanium

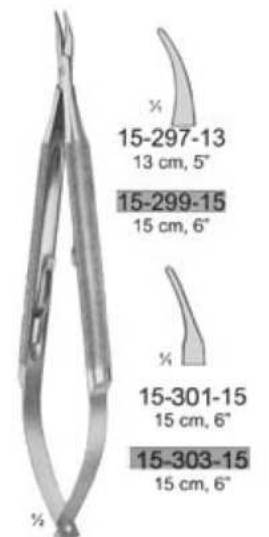

15-297-13 13 cm, 5"

15-299-15 15 cm, 6"

15-299-15 15 cm, 6"

15-301-15 15 cm, 6"

15-303-15 15 cm, 6"

15-301-15 15 cm, 6"

15-303-15 15 cm, 6"

BARRAQUER
15-297-13
15-303-15 15 cm, 6"

Titanium

Smooth jaws
glattes Maul
bocas lisas
More lisées
Morso liscio

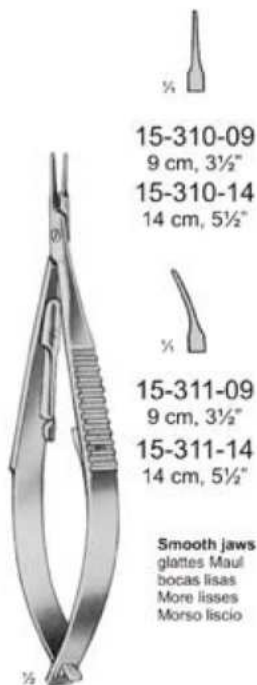

15-310-09
9 cm, 3½"
15-310-14
14 cm, 5½"

15-311-09
9 cm, 3½"
15-311-14
14 cm, 5½"

Smooth jaws
glattes Maul
bocas lisas
More lisas
Morso liscio

CASTROVIEJO
15-310-09
15-311-14

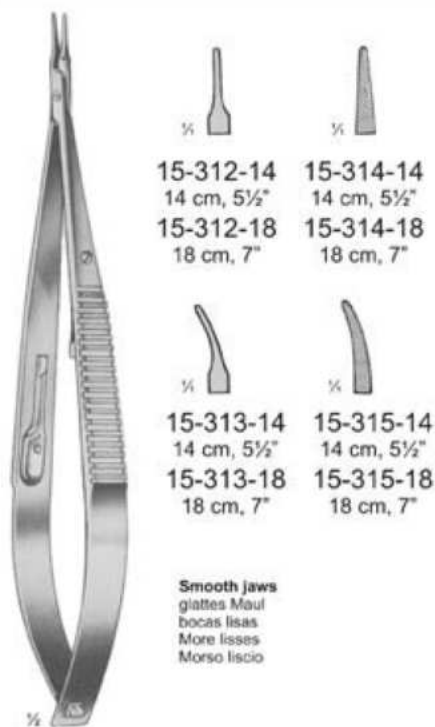

15-312-14 15-314-14
14 cm, 5½" 14 cm, 5½"
15-312-18 15-314-18
18 cm, 7" 18 cm, 7"

15-313-14 15-315-14
14 cm, 5½" 14 cm, 5½"
15-313-18 15-315-18
18 cm, 7" 18 cm, 7"

Smooth jaws
glattes Maul
bocas lisas
More lisas
Morso liscio

CASTROVIEJO
15-312-14
15-315-18



15-320-12
12 cm, 4¾"

15-321-14
14 cm, 5½"

Smooth jaws
glattes Maul
bocas lisas
More lisas
Morso liscio

BARRAQUER
15-320-12
15-321-14

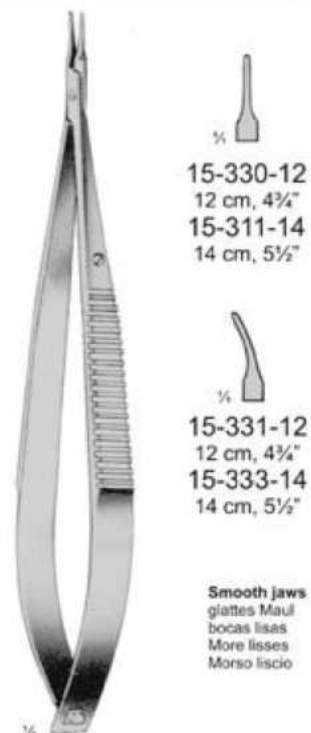

15-330-12
12 cm, 4¾"
15-311-14
14 cm, 5½"

15-331-12
12 cm, 4¾"
15-333-14
14 cm, 5½"

Smooth jaws
glattes Maul
bocas lisas
More lisas
Morso liscio

BARRAQUER
15-330-12
15-333-14

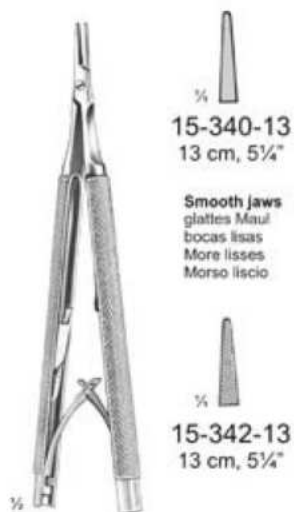

15-340-13
13 cm, 5¼"

Smooth jaws
glattes Maul
bocas lisas
More lisas
Morso liscio

15-342-13
13 cm, 5¼"

CASTROVIEJO
15-340-13
15-342-13



BOYNTON
15-344-16
16 cm, 6¼"



KALT
15-346-14
14 cm, 5½"



STEVENS
15-348-13 14 cm, 5½"
15-348-15 15 cm, 6"



COLLIER
15-350-12
12,5 cm 5"

Smooth jaws, with special groove
Glattes Maul mit Spezialkehle
bocas lisas, con acanaladura especial
mors lisses, rainurés
morso liscio con scanalatura speciale



DERF
15-354-12
12 cm, 4 3/4"

With convex jaws
Mit konvexen maulteilen
Con bocas convexas
Avec mors convexas
Con morso diagonale

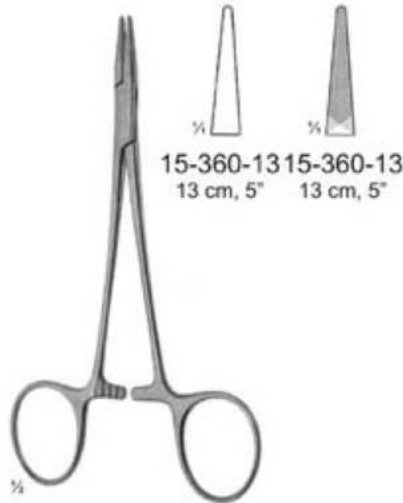

HALSEY
15-360-13
15-360-13
13 cm, 5" 13 cm, 5"

Smooth jaws
Glattes Maul
bocas lisas
Mors lisses
Morso liscio

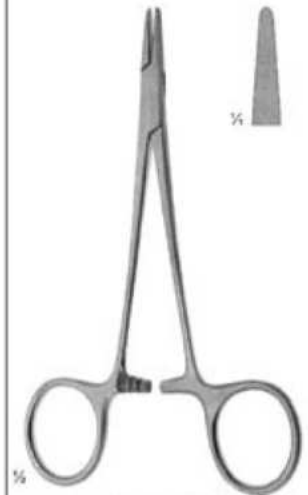

WEBSTER
15-368-13
13 cm, 5"

Smooth jaws
Glattes Maul
Bocas Lisas
Mors Lisses
Morso liscio

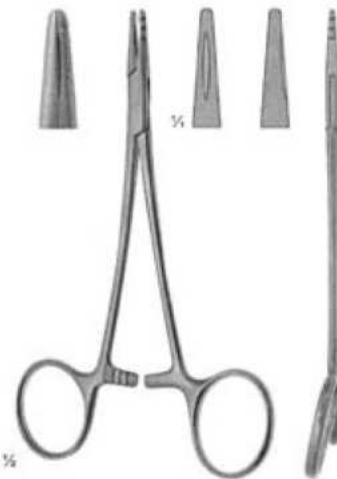

NEIVERT
15-372-13
13 cm, 5"

Smooth jaws, with special groove
Glattes Maul mit Spezialkehle
bocas lisas, con acanaladura especial
mors lisses, rainurés
morso liscio con scanalatura speciale



BROWN
15-376-13
13 cm, 5"

With convex jaws
Mit konvexen maulteilen
Con bocas convexas
Avec mors convexas
Con morso diagonale



BAUMGARTNER
15-382-13
15-384-13
13 cm, 5 1/2" 13 cm, 5 1/2"

Light patterns
Leichte modelle
modelos ligeros
modèles légers
modelli leggeri

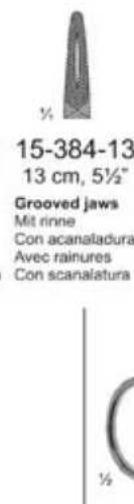

BAUMGARTNER
15-392-13
15-394-13
13 cm, 5 1/4" 13 cm, 5 1/4"

Heavy patterns
Kräftige modelle
Modelos robustos
Modèles forts
Modelli robusti

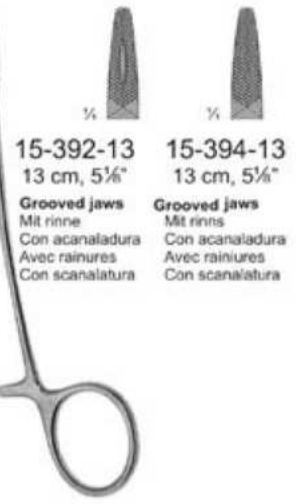

BAUMGARTNER
15-382-13 15-384-13
13 cm, 5 1/2" 13 cm, 5 1/2"
Grooved jaws Mit rinne
Ohne rinne
Sin acanaladura
Sans rainures
Senza scanalatura
Grooved jaws Mit rinne
Con acanaladura
Avec rainures
Con scanalatura
Grooved jaws Mit rinne
Con acanaladura
Avec rainures
Con scanalatura

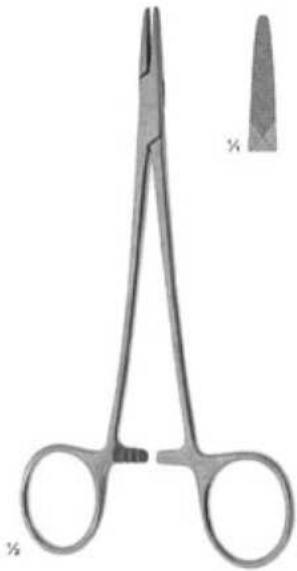

CRILE-MURRAY
15-400-15
15 cm, 6"

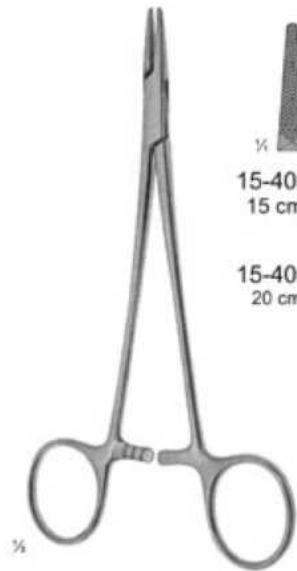

CRILE-WOOD
15-402-15
15-402-20
15 cm, 6"
20 cm, 8"



NEWORLEANS
15-408-18
18 cm, 7"



ADSON
15-412-18
18 cm, 7"



MAYO-HEGAR
15-422-14
15-422-30

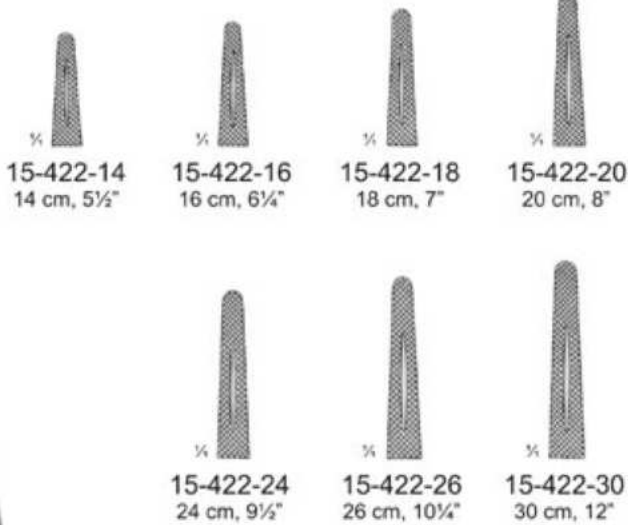

Standard patterns
Standard modelle
Modelos standard
Modèles standard
Modelli standard

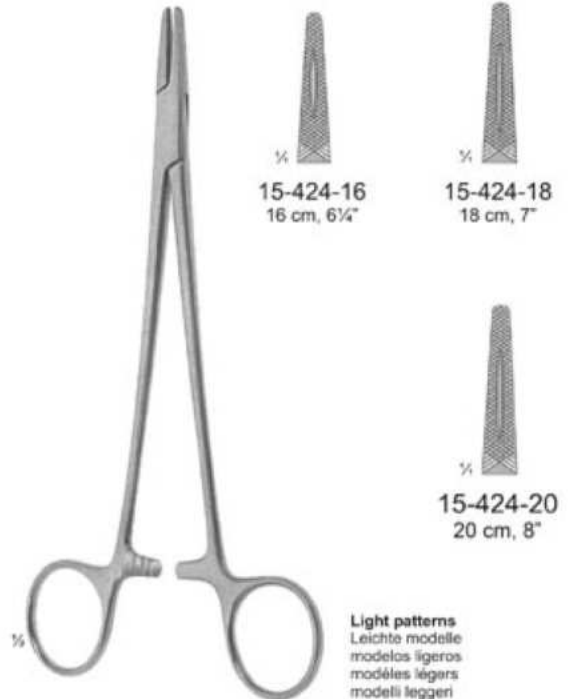

MAYO-HEGAR
15-424-16
15-424-20

Light patterns
Leichte modelle
modelos ligeros
modèles légers
modelli leggeri



MASSON
15-440-27
27 cm, 10½"

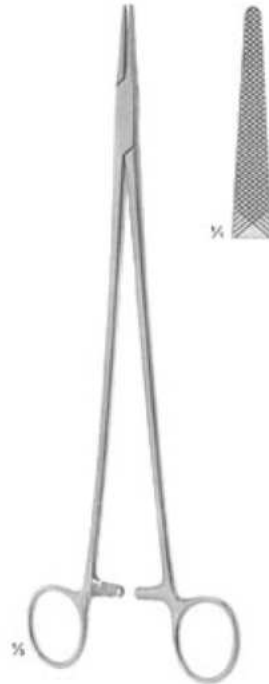

WANGENSTEEN
15-444-27
27 cm, 10½"

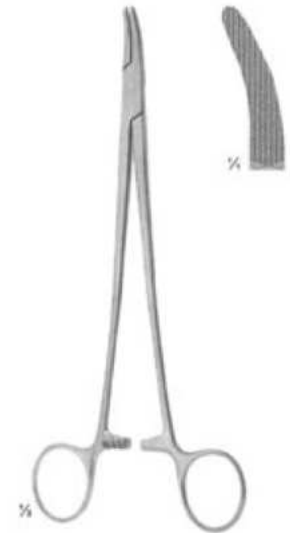

HEANEY
15-450-21
21 cm, 8¼"



FINOCCHIETTO
15-451-27
27 cm, 10½"

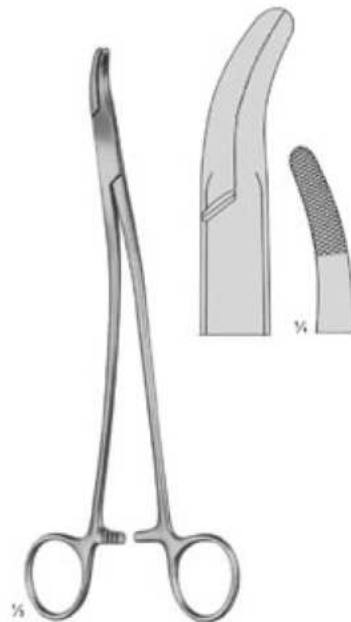

STRATTE
15-455-23
23 cm, 9"

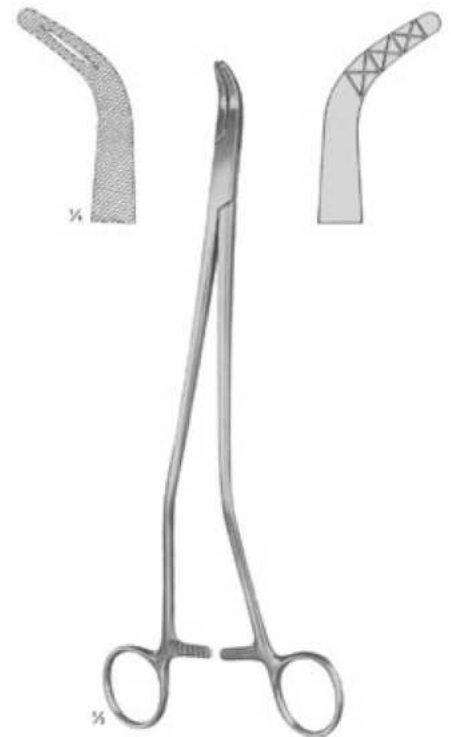

JOHNSON
15-459-27
27 cm, 10½"

Needle Holders with scissors

Nadelhalter mit schere
Porta-agujas con tijera
Porte-aiguilles avec ciseaux
Portaghi con forbici



OLSEN-HEGAR MINI
15-470-12
15-472-12



15-470-12
12 cm, 5 1/4"



15-472-12
12 cm, 5 1/4"

Smooth jaws
glattes Maul
bocas lisas
More lisas
Morso liscio



OLSEN-HEGAR
15-474-14
15-474-16
16,5 cm, 6 1/2"



OLSEN-HEGAR
15-478-18
18 cm, 7"



OLSEN-HEGAR
15-490-17
17 cm, 6 3/4"



MINI-GILLIES
15-491-15
15 cm, 6"

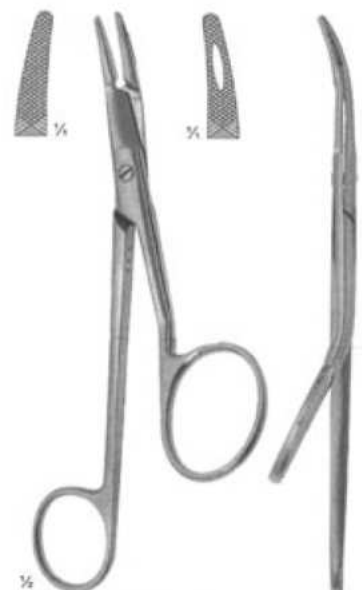

GILLIES
15-493-16
16 cm, 6 1/2"



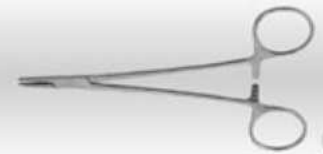

15-500-14
14 cm, 5½"

15-500-17
17 cm, 6¾"

15-500-20
20 cm, 8"

MATHIEU
15-500-14
15-500-20



15-512-14
14 cm, 5½"

15-512-17
17 cm, 6¾"

15-514-14
14 cm, 5½"

15-514-17
17 cm, 6¾"

15-512-20
20 cm, 8"

15-514-20
20 cm, 8"

MATHIEU
15-512-14
15-512-20



MATHIEU
15-514-14
15-514-20



15-522-14
14 cm, 5½"

15-522-17
17 cm, 6¾"

MATHIEU
15-522-14
15-522-17



CRILE
15-560-15
15 cm 6"



Elastic pattern
elastisches Modell
modelo elástico
modèle souple
modello elastico

TOENNIS
15-566-18
18 cm, 7"