



Thorax, Lung
Thorax, Lunge
Troácico, Pulmón
Thorax, Poumon
Torace, Polmone

Rib Shears
Rippenscheren
Costótomos
Costotomes
Costotomi

Sternum Chisel
Sternummeißel
Cinzel para esternón
Cisaille et ciseau-burins à sternum
Scalpello per sterno



31-100-23
23 cm, 9"

Rib shears
Rippenscheren
Costótomo
Costotome
Costotomo



31-102-22
22 cm, 8 $\frac{3}{4}$ "

Rib shears
Rippenscheren
Costótomo
Costotome
Costotomo



GLUCK
31-106-22
22 cm, 8 $\frac{3}{4}$ "

Rib shears with drawing cut

Rippenscheren mit ziehendem schnitt

Costótomo con hoja de retroacción

Costotome avec lame excentrée

Costotomo con lama eccentrica a scorrimento



SAUERBRUCH
31-110-26
26 cm, 10 $\frac{1}{4}$ "

Rib shears
Rippenscheren
Costótomo
Costotome
Costotomo



LEBSCHKE
31-114-24
24.5 cm, 9 $\frac{3}{4}$ "

Sternum chisel
Sternummeißel
Cinzel para esternón
Cisaille et ciseau-burins à sternum
Scalpello per sterno



BETHUNE
31-116-34
34.5 cm, 13 $\frac{1}{2}$ "

Rib shears
Rippenscheren
Costótomo
Costotome
Costotomo



Rib shears
Rippenschere
Costótomo
Costotome
Costotomo

1/2

STILLE-GIERTZ
31-120-27
27 cm, 10 1/2"



1/4



1/4



Rib shears
Rippenschere
Costótomo
Costotome
Costotomo

1/2

SAUERBRUCH-FREY
31-122-36
36 cm, 14"

For the first rib
Für die erste Rippe
Para la primera costilla
Pour la première côte
Per la prima costola



1/2

MARKWALDER
31-126-20
20 cm, 8"



1/2

SEMB
31-128-22
22.5cm, 9"



½

STILLE-LISTON
31-130-27
27 cm, 10½"



½

LISTON-KEY
31-132-27
27 cm, 10½"

Bone cutting forceps, S - shaped, for posterior rib stumps

Knochensplitterzange, doppelt gebogen, für hintere Rippenstümpfe

Pinza cortante para huesos, doble curvada, para los muñones de las costillas posteriores

Pincès coupantes à os, double courbure pour extrémité des côtes postérieures

Cesoia per ossa, ad., s" per estremità delle costole posteriori

Bone cutting forceps, curved sideways, for anterior rib stumps

Knochensplitterzange, Seitwärts gebogen, für vordere Rippenstümpfe

Pinza cortante para huesos, curvada lateral, para los muñones de las costillas anteriores

Pincès coupantes à os, courbure latérale pour extrémité des côtes antérieures

Cesoia per ossa, curve lateralmente per le estremità delle costole anteriori



½

LISTON-KEY
31-136-27
27 cm, 10½"



½

SEMB
31-137-24
24 cm, 9½"



31-140-01

for children
Für Kinder
para niños
pour enfants
per bambini

DOYEN
31-140-01
31-140-04 ¼



31-140-02
17 cm, 6¾"



31-140-03
17 cm, 6¾" ¼

For adults
für erwachsene
pour adultes
pour adultes
per adulti

DOYEN
31-140-01
31-140-04 ¼



31-144-01

for children
Für Kinder
para niños
pour enfants
per bambini

31-144-01
15,5 cm, 6" ¼

DOYEN
31-144-01
31-144-02



31-144-01 ¼



31-144-02
15,5 cm, 6"

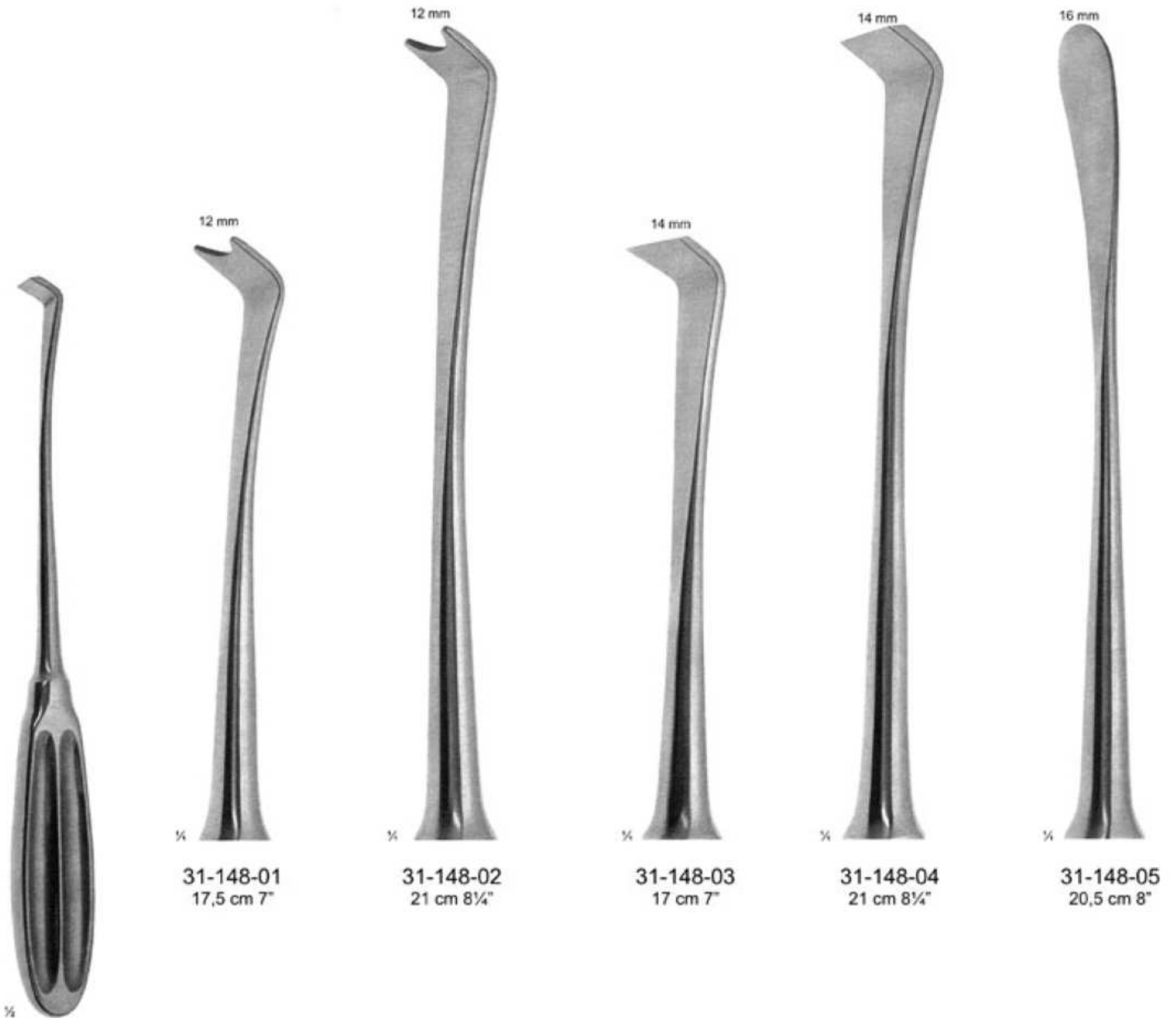

31-148-01
17,5 cm 7"

31-148-02
21 cm 8¼"

31-148-03
17 cm 7"

31-148-04
21 cm 8¼"

31-148-05
20,5 cm 8"

SEMB
31-148-01
31-148-05

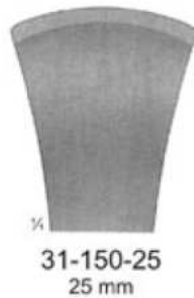
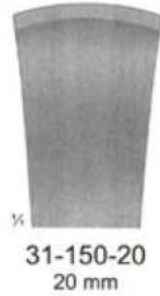
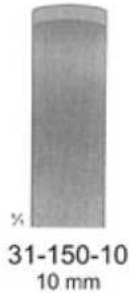

LAMBOTTE
31-150-05
31-150-25
21 cm, 8 1/4"

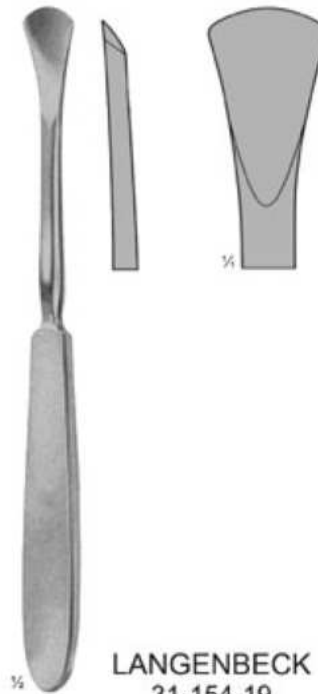

LANGENBECK
31-154-19
19 cm, 7 1/2"

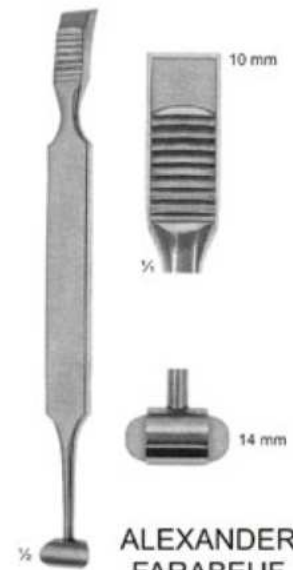

ALEXANDER FARABEUF
31-158-15
15 cm, 6"

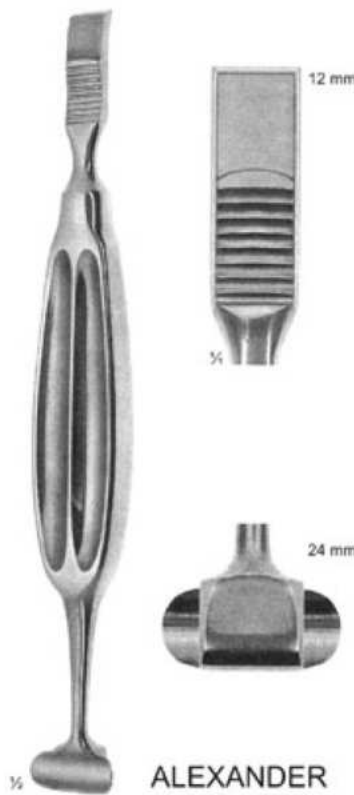

ALEXANDER FARABEUF
31-164-20
20 cm, 8"

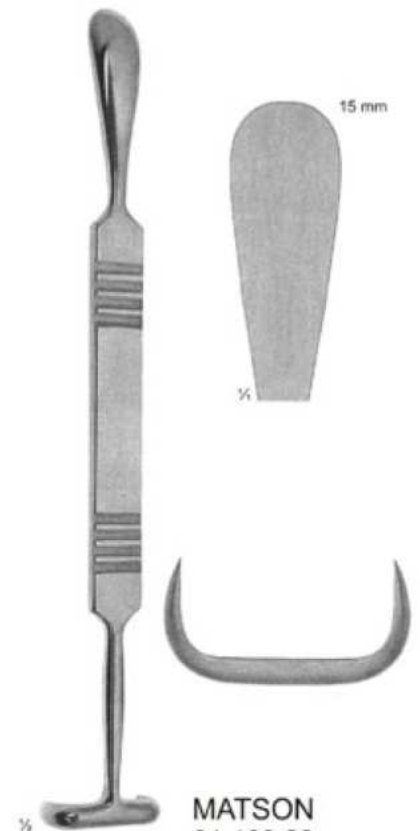

MATSON
31-166-22
22 cm, 8 3/4"



For babies
für Säuglinge
para bebés
pour bébés
per neonati

1/3

**FINOCCHIETTO
BABY**
31-170-01

	A	B	C
31-170-01	18 mm	20 mm	75 mm
31-172-01	18 mm	20 mm	75 mm

Aluminium



For babies
für Säuglinge
para bebés
pour bébés
per neonati

1/3

**FINOCCHIETTO
HAIGHT**
31-174-01

	A	B	C
31-174-01	31 mm	31 mm	100 mm
31-176-01	31 mm	31 mm	100 mm

Aluminium



For Children
für Kinder
Para niños
Pour enfants
Per bambini

1/3

**FINOCCHIETTO
INFANT**
31-178-01

	A	B	C
31-178-01	15mm	15 mm	75 mm
31-180-01	15mm	15 mm	75 mm

Aluminium



**RIENHOOF
FINOCCHIETTO**
31-182-01

1/3

	A	B	C
31-182-01	30 mm	32 mm	156 mm
31-184-01	30 mm	32 mm	156 mm

Aluminium



For adults
für Erwachsene
para adultos
pour adultes
per adulti

FINOCCHIETTO
31-190-01
31-192-15

1/3

	A	B	C
31-190-01	30 mm	45 mm	150 mm
31-190-02	40 mm	40 mm	165 mm
31-190-03	40 mm	45 mm	135 mm
31-190-04	46 mm	62 mm	190 mm
31-190-05	52 mm	62 mm	175 mm
31-190-06	52 mm	62 mm	250 mm
31-190-07	52 mm	62 mm	300 mm
31-190-08	80 mm	65 mm	175 mm
31-190-09	80 mm	65 mm	200 mm
31-190-10	80 mm	65 mm	250 mm
31-190-11	80 mm	65 mm	300 mm
31-190-12	85 mm	65 mm	175 mm
31-190-13	85 mm	65 mm	200 mm
31-190-14	85 mm	65 mm	250 mm
31-190-15	85 mm	65 mm	300 mm

	A	B	C
31-192-01	30 mm	45 mm	150 mm
31-192-02	40 mm	40 mm	165 mm
31-192-03	40 mm	45 mm	135 mm
31-192-04	46 mm	62 mm	190 mm
31-192-05	52 mm	62 mm	175 mm
31-192-06	52 mm	62 mm	250 mm
31-192-07	52 mm	62 mm	300 mm
31-192-08	80 mm	65 mm	175 mm
31-192-09	80 mm	65 mm	200 mm
31-192-10	80 mm	65 mm	250 mm
31-192-11	80 mm	65 mm	300 mm
31-192-12	85 mm	65 mm	175 mm
31-192-13	85 mm	65 mm	200 mm
31-192-14	85 mm	65 mm	250 mm
31-192-15	85 mm	65 mm	300 mm

Aluminium

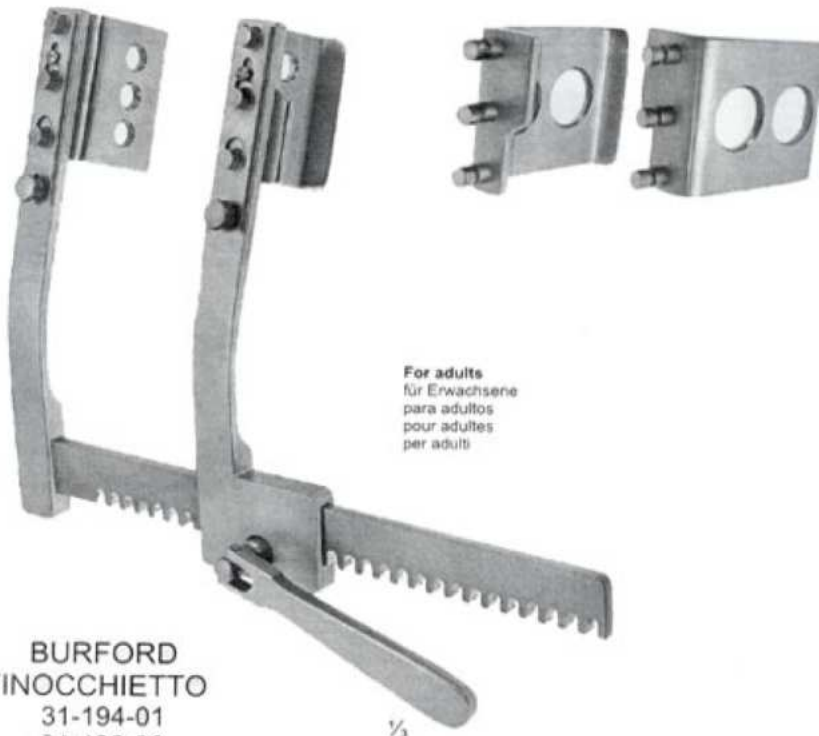

For adults
für Erwachsene
para adultos
pour adultes
per adulti

**BURFORD
FINOCCHIETTO**
31-194-01
31-196-06

1/3

With 2 pairs of blades
mit 2 paar Valven
con 2 pares de valvas
avec 2 paires de valves
con 2 paia di valve

Spreading
Spreizweite
Abertura
Ouverture
Apertura

	A	B	C
31-194-01	48 mm	64 mm	210 mm
31-194-02	77 mm	64 mm	
31-194-03	48 mm	64 mm	260 mm
31-194-04	77 mm	64 mm	
31-194-05	48 mm	64 mm	300 mm
31-194-06	77 mm	64 mm	

	A	B	C
31-194-01	48 mm	64 mm	210 mm
31-194-02	77 mm	64 mm	
31-194-03	48 mm	64 mm	260 mm
31-194-04	77 mm	64 mm	
31-194-05	48 mm	64 mm	300 mm
31-194-06	77 mm	64 mm	

Aluminium

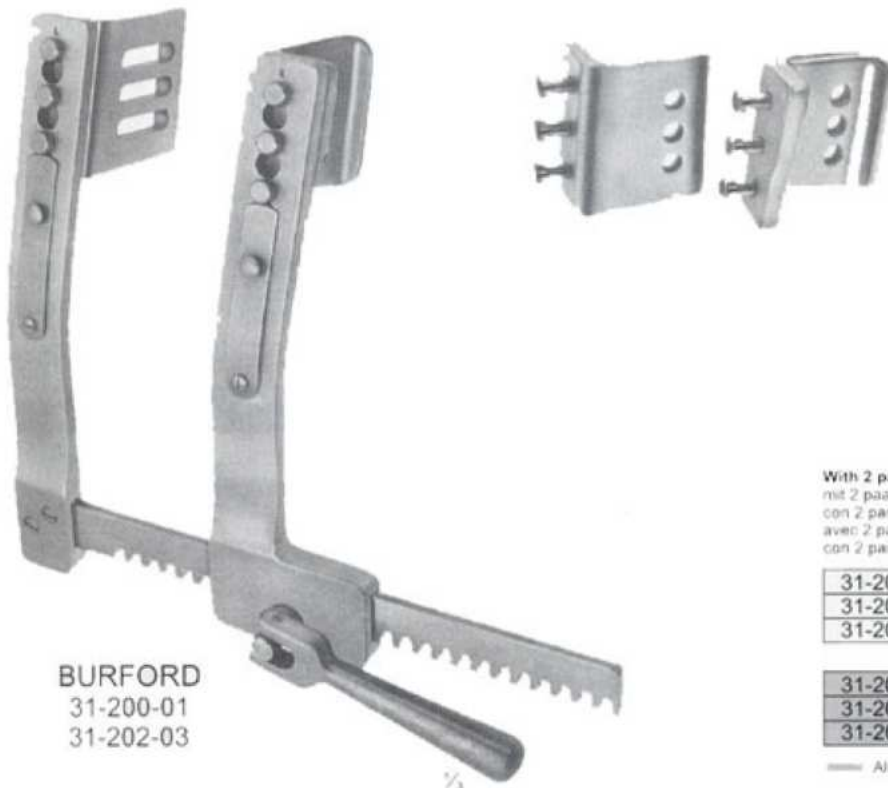

BURFORD
31-200-01
31-202-03

With 2 pairs of blades
mit 2 paar Valven
con 2 pares de valvas
avec 2 paires de valves
con 2 paia di valve

Spreading
Spreizweite
Abertura
Ouverture
Apertura

31-200-01	47 X 62 mm + 65 x 62 mm	200 mm
31-200-02	47 X 62 mm + 65 x 62 mm	260 mm
31-200-03	47 X 62 mm + 65 x 62 mm	300 mm

31-202-01	47 X 62 mm + 65 x 62 mm	200 mm
31-202-02	47 X 62 mm + 65 x 62 mm	260 mm
31-202-03	47 X 62 mm + 65 x 62 mm	300 mm

Aluminium

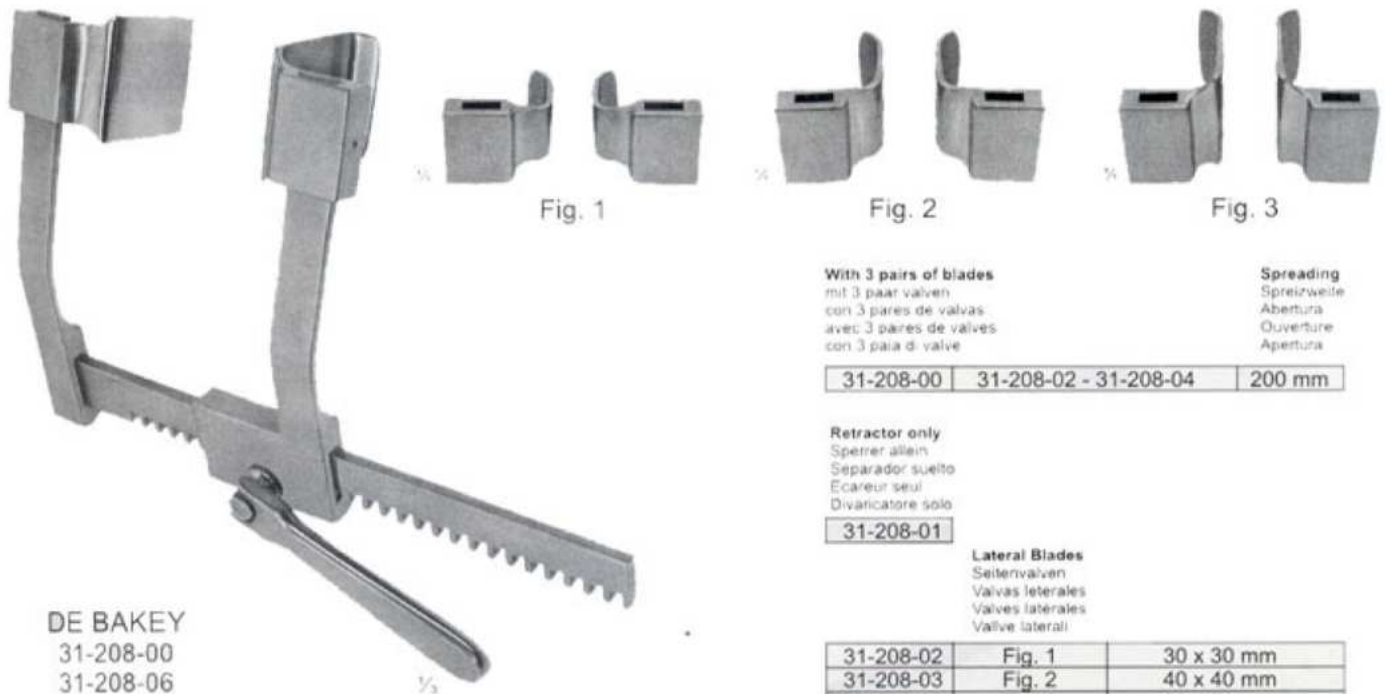

DE BAKEY
31-208-00
31-208-06

With 3 pairs of blades
mit 3 paar Valven
con 3 pares de valvas
avec 3 paires de valves
con 3 paia di valve

Spreading
Spreizweite
Abertura
Ouverture
Apertura

31-208-00	31-208-02 - 31-208-04	200 mm
-----------	-----------------------	--------

Retractor only
Sperrer allein
Separador suelto
Ecarteur seul
Divaricatore solo

31-208-01

Lateral Blades
Seitenvalven
Valvas laterales
Valves laterales
Valve laterali

31-208-02	Fig. 1	30 x 30 mm
31-208-03	Fig. 2	40 x 40 mm
31-208-04	Fig. 3	50 x 50 mm



COOLEY

	A	B	C
31-210-01	12mm	16 mm	95 mm
31-212-01	12mm	16 mm	95 mm

Aluminium



COOLEY

	A	B	C
31-210-02	15mm	30 mm	140 mm
31-212-02	15mm	30 mm	140 mm
31-210-03	21 mm	44 mm	150 mm
31-212-03	21 mm	44 mm	150 mm

Aluminium



COOLEY

	A	B	C
31-210-04	35 mm	50 mm	200 mm
31-212-04	35 mm	50 mm	200 mm

Aluminium



CASTANEDA

	A	B	C
31-220-01	10,5 mm	32 mm	65 mm
31-222-01	10,5 mm	32 mm	65 mm

Aluminium



CASTANEDA

	A	B	C
31-220-02	12 mm	45 mm	70 mm
31-222-02	12 mm	45 mm	70 mm

Aluminium



CASTANEDA

	A	B	C
31-220-03	15 mm	60 mm	120 mm
31-222-03	15 mm	60 mm	120 mm

Aluminium



MORSE

31-224-01 31-224-02
31-226-01 31-226-02
For children **For adults**
für Kinder für Erwachsene
para niños para adultos
pour enfants pour adultes
per bambini per adulti

	A	B	C
31-224-01	17 mm	22 mm	160 mm
31-226-01	17 mm	22 mm	160 mm
31-224-02	22 mm	27 mm	200 mm
31-226-02	22 mm	27 mm	200 mm

Aluminium



Rib spreader
Rippensperrer
Separador costal
Ecarteur à côtes
Divaricatori costale

CHEVALIER

	A	B	C
31-228-01	27 mm	100 mm	190 mm



TUFFIER

	A	B	C
31-230-01	45 mm	45 mm	160 mm
31-232-02	45 mm	45 mm	160 mm

Aluminium



HAIGHT

	A	B	C
31-234-01	30 mm	30 mm	90 mm
31-236-01	30 mm	30 mm	90 mm
31-234-02	30 mm	30 mm	120 mm
31-236-02	30 mm	30 mm	120 mm

Aluminium



Fig. 1



Fig. 2



Fig. 3



Fig. 4



Fig. 5

With 3 pairs of blades
mit 3 paar valven
con 3 pares de valvas
avec 3 paires de valves
con 3 paia di valve

Spreading
Sprenzweite
Abertura
Ouverture
Apertura

31-240-00	31-240-02 - 31-240-06	200 mm
-----------	-----------------------	--------

Retractor only
Sperrer allein
Separador suelto
Ecarteur seul
Divaricatore solo

31-240-01

Lateral Blades
Seitenvalven
Valvas laterales
Valves laterales
Valve laterali

31-240-02	Fig. 1	60 x 60 mm
31-240-03	Fig. 2	50 x 80 mm
31-240-04	Fig. 3	40 x 100 mm
31-240-05	Fig. 4	80 x 60 mm
31-240-06	Fig. 5	50 x 56 mm



DE BAKEY
31-240-00
31-240-06

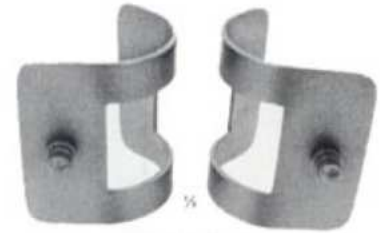

31-242-02
48 x 66 mm



31-242-03
70 x 75 mm

MERCEDES

31-242-00

Mercedes Retractor
Mercedes Sperrer
Retractor Mercedes
Ecarteur Mercedes
Divaricatore Mercedes

31-242-00

Retractor only
Sperrer allein
Separador suelto
Ecarteur seul
Divaricatore solo



BAILEY-BABY
31-244-14
14 cm, 5½"



BAILEY
31-246 16
16 cm, 6¼"



BAILEY GIBBON
31-228-16
16 cm, 6¼"



SELLORS
31-250-19
19 cm, 7½"



COOLEY
31-234-23
23 cm, 9"

Left
Links
Izquierdo
Gauche
Sinistro



COOLEY
31-236-21
21,5 cm, 8½"

Right, serrated
Rechts, gerieft
Derecho, estriado
Droite, cannelé
Destro, seghettato



COOLEY
31-238-21
21,5 cm, 8½"

Rights
Rechts
Derecho
Droite
Destro



Blade opening from 8 - 15 mm
Spreizweite 8 - 15 mm
Abertura de 8 a 15 mm
Ouverture 8 - 15 mm
Apertura mm 8 - 15 mm



Blade opening from 8 - 42 mm
Spreizweite 8 - 42 mm
Abertura de 8 a 42 mm
Ouverture 8 - 42 mm
Apertura mm 8 - 42 mm



COOLEY
31-260-00

For mitral valve (Pediatric)
Für Mitralklappenstenosen (Kinder)
Para estenosis mitral (Niños)
Pour sténoses mitrales (enfants)
Per stenosi mitrali (pediatrico)



TUBBS
31-260-01

For mitral valve
Für Mitralklappenstenosen
Para estenosis mitral
Pour sténoses mitrales
Per stenosi mitrali

Lung Retractors

Lungenhaken
Separadores para el pulmón
Ecarteur à poumons
Divaricatori per polmone



ALLISON
31-264-30
30 cm, 12"



ALLISON
31-264-32
32 cm, 12½"

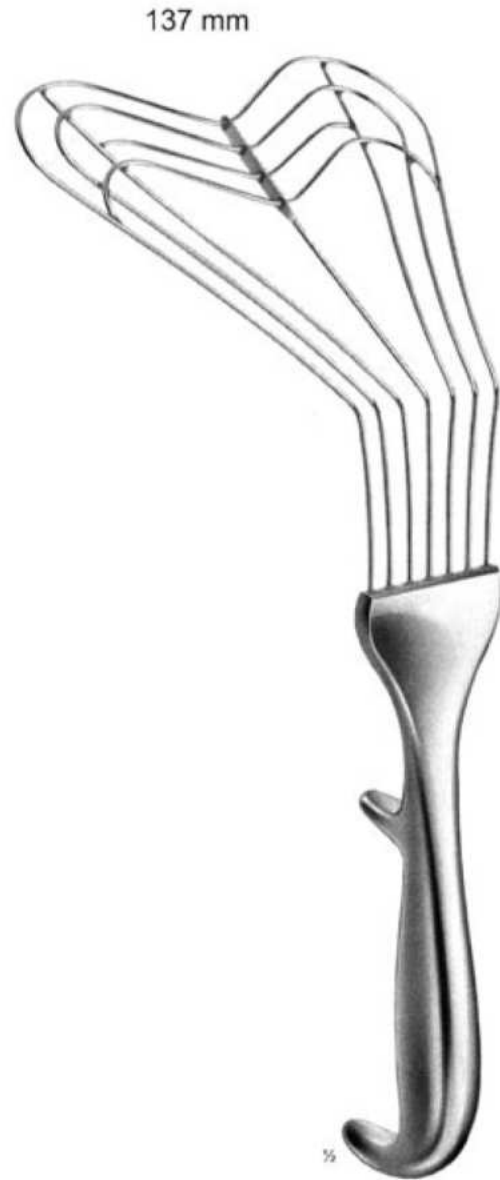

31-266-26
26 cm, 10¼"

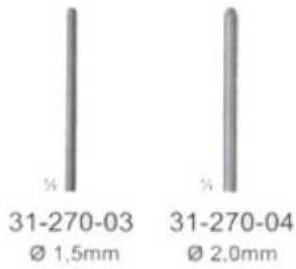
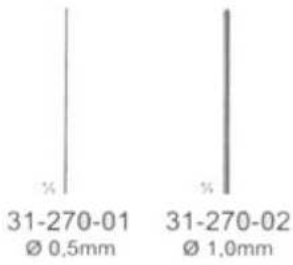

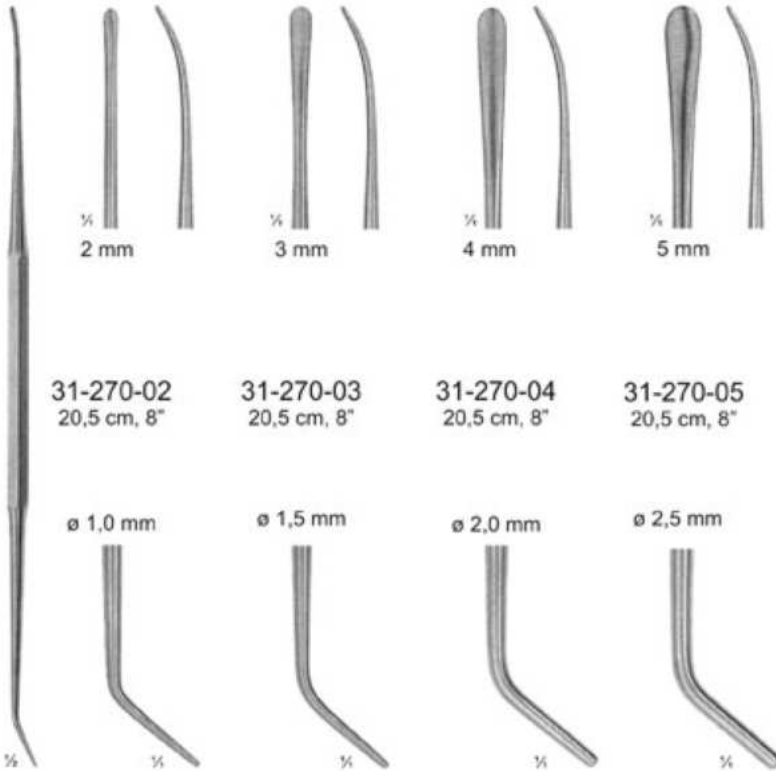

ROBB
31-270-02
31-270-05

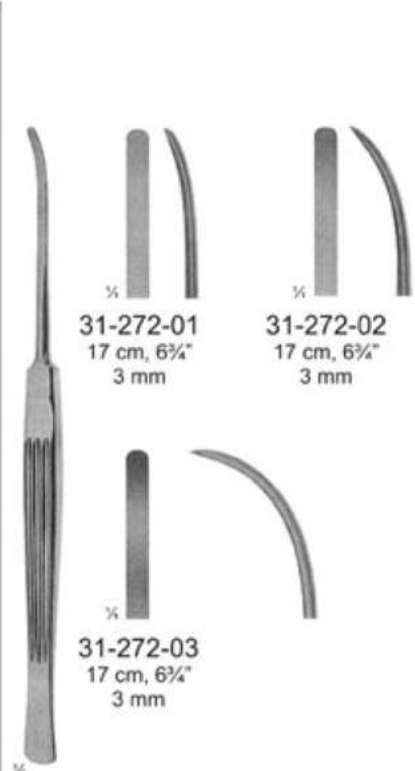

LEMMON
31-272-01
31-272-03

Intima spatulas
Intima-Spatel
Espátula para la íntima
Spatule pour la tunique interne
Spatola per íntima

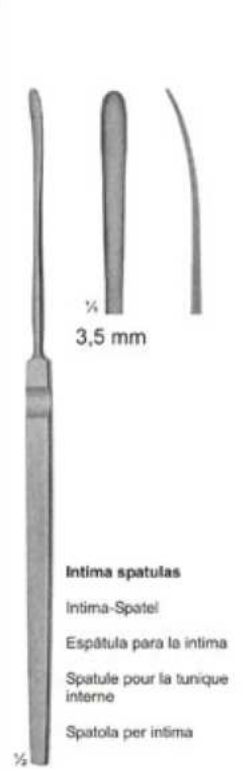

HALLE
31-274-16
16,5 cm, 6½"



CANNON
31-276-15
31-276-18

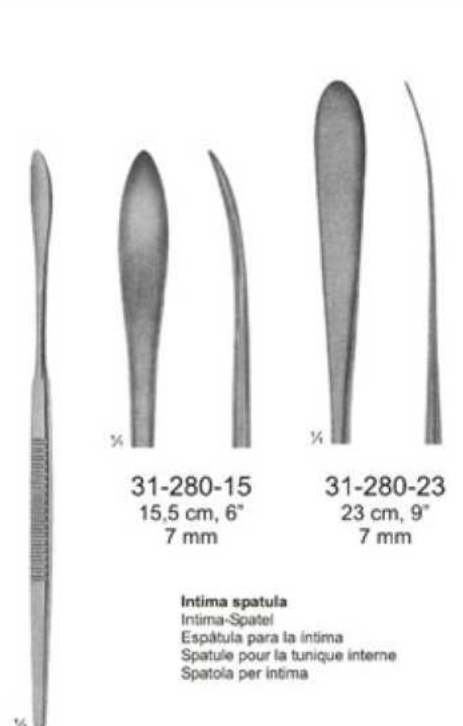

SCHMID
31-280-15
31-280-23

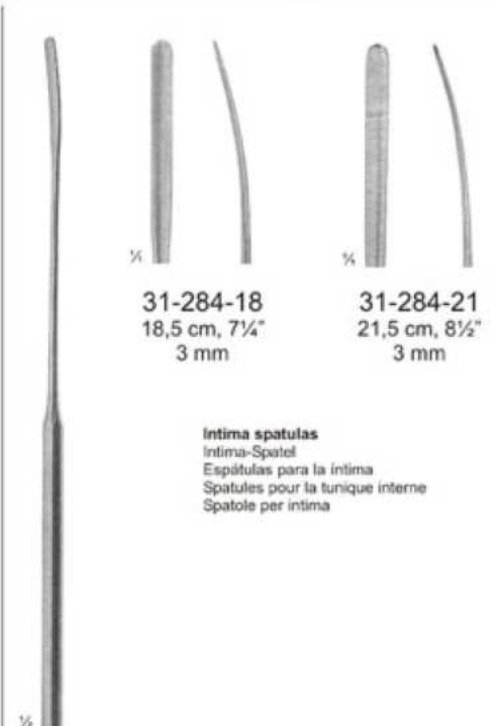

31-284-18
31-284-21